

# Oil Review

Middle East

VOLUME 25 | ISSUE 4 2022

## Oil & gas sees upturn in project activity

- PDO navigates the energy transition
- The evolving nature of oil spill response
- Optimising flow meter data
- Enhancing production efficiency with the digital twin
- The benefits of tomographic imaging

**25**  
Years

Serving the regional oil & gas sector since 1997



شركة إسمنت عمان (ش.م.ع.ج)  
Oman Cement Company (S.A.O.G)



## Oil Well Cement

Our products of oil well cement which is used in oil well drilling process is of high quality meeting the international standard. The manufacturing of this type of cement is with accordance to the **American petroleum Institute (API)**.

The company is certified from the API. The laboratory at the factory is stat-to-art. Quality Control is supported by its own central laboratory consisting of robotics, X-ray spectrometers, laser particle size analysers and computerized physical properties testing equipment handled by high qualified and experienced personnel. Quality Control in **Oman Cement Company** is checked under the strict production process control throughout the production process and the completed product.



## Oil Well Cement

Class-G (HSR) and Class-A (O) in accordance with - API Spec 10A

Exported to Qatar, Kuwait, Iraq, Yemen, Libya, Pakistan, Tanzania, Sudan, Syria, Cameroon, Turkmenistan, India, Bangladesh and Venezuela.



Oman Cement Company (S.A.O.G)

P.O.Box 560 Ruwi. Post Code 112, Oman

Email: [customerssupport@omacement.com](mailto:customerssupport@omacement.com) / Email: [mustafa.mujaiani@omacement.com](mailto:mustafa.mujaiani@omacement.com)

**Editor:** Louise Waters - ✉ [louise.waters@alaincharles.com](mailto:louise.waters@alaincharles.com)

**Editorial and Design team:** Mariam Ahmad, Prashanth AP, Fyna Ashwath, Miriam Brtkova, Praveen CP, Robert Daniels, Shivani Dhruv, Matthew Hayhoe, Tulana Nayak, Prince Kariappa and Rahul Puthenveedu

**Publisher:** Nick Fordham

**Sales Manager:** Richard Rozelaar  
✉ [richard.rozelaar@alaincharles.com](mailto:richard.rozelaar@alaincharles.com)

**Magazine Sales Manager:** Tanmay Mishra  
☎ +91 98800 75908  
✉ [tanmay.mishra@alaincharles.com](mailto:tanmay.mishra@alaincharles.com)

#### International Representatives

**Nigeria** **Bola Olowo**  
☎ +234 8034349299  
✉ [bola.olowo@alaincharles.com](mailto:bola.olowo@alaincharles.com)

**USA** **Michael Tomashefsky**  
☎ +1 203 226 2882 ☎ +1 203 226 7447  
✉ [michael.tomashefsky@alaincharles.com](mailto:michael.tomashefsky@alaincharles.com)

#### Head Office:

Alain Charles Publishing Ltd  
University House, 11-13 Lower Grosvenor Place, London,  
SW1W 0EX, United Kingdom  
☎ +44 (0) 20 7834 7676 ☎ +44 (0) 20 7973 0076

#### Middle East Regional Office:

Alain Charles Middle East FZ-LLC  
Office L2-112, Loft Office 2, Entrance B,  
P.O. Box 502207, Dubai Media City, UAE  
☎ +971 4 448 9260, ☎ +971 4 448 9261

**Production:** Dinesh Dhayalan, Ranjith Ekambaram and  
Eugenia Nelly Mendes  
✉ [production@alaincharles.com](mailto:production@alaincharles.com)

**Subscriptions:** ✉ [circulation@alaincharles.com](mailto:circulation@alaincharles.com)

**Chairman:** Derek Fordham

**Printed by:** Buxton Press

**Printed in:** June 2022

© Oil Review Middle East ISSN: 1464-9314

## → Editor's note

THIS ISSUE's COVER story looks at the buoyant project market in the Middle East, as the region's NOCs ramp up capital expenditure in response to the tightening oil market and high oil prices. Projects such as Saudi Arabia's Jafurah unconventional gas field development and Qatar Energy's North Field expansion offer fertile opportunities to contractors (p16).

Petroleum Development Oman (PDO) celebrates its 85th anniversary this year, and looks in fine form, having unveiled the Yibal Khuff project in 2021, its second largest ever. At the same time, the company is looking to the future and developing new low-carbon value chains (p14).

We also address the evolving nature of oil spill response as new marine fuels are developed (p20), while our technology section covers the optimisation of flow meter data for better decision making (p24), boosting production while reducing methane emissions (p30) and addressing industry challenges with tomographic imaging (p34).

## → Contents

### Calendar

#### 4 Executives' calendar

Listings of events, and a look ahead to ADIPEC and SOGAT

### News

#### 8 Developments

A round-up of the latest news from around the region

### PDO Review

#### 14 Navigating a path through the energy transition

Petroleum Development Oman (PDO) celebrates its 85th anniversary this year, while looking to the future

### EPC

#### 16 Building tomorrow's energy supply

The latest EPC contract activity highlights the massive Gulf energy investment drive

### Oil Spill

#### 20 The evolving nature of oil spill response

Considerations oil spill responders need to be aware of as new marine fuels are developed

### Technology

#### 24 Optimising flow meter data for better decision making

How flow meter data can be optimised by generalising data-driven models

#### 30 Boosting production while reducing emissions

Treating liquid loaded gas wells in a method that reduces methane emissions

#### 34 Addressing industry challenges with tomographic imaging

How tomographic solutions can help reduce OPEX, avoid unplanned shutdowns, monitor product quality and cut carbon emissions

#### 36 Enhancing production efficiency with the digital twin

How the digital twin can help companies achieve their production and sustainability objectives

### Energy Transition

#### 38 Three trends shaping the energy transformation

How decarbonisation, decentralisation and digitisation are shaping the energy sector

### Finance

#### 40 Seeing strong growth potential in the Middle East

The expansion of Houlihan Lokey's oil and gas team in the Middle East

### Shipping

#### 41 Prospects for the shipping market

The state of play for shipping, and the future bunker fuel market

### Innovations

#### 42 Product advances in oil and gas

### Arabic

#### 4 Analysis

Front cover image: Adobe Stock

## → Executives' Calendar, 2022

SEPTEMBER			
5-8	<b>Gastech</b>	MILAN	<a href="http://www.gastechevent.com">www.gastechevent.com</a>
5-8	<b>SOGAT</b>	ABU DHABI	<a href="http://www.sogat.org">www.sogat.org</a>
6-7	<b>MENA HSE Forum</b>	DUBAI	<a href="http://www.hse-forum.com">www.hse-forum.com</a>
OCTOBER			
3-5	<b>SPE ATCE</b>	HOUSTON	<a href="http://www.atce.org">www.atce.org</a>
4-6	<b>Energy Intelligence Forum</b>	LONDON	<a href="http://www.energyintelligenceforum.com">www.energyintelligenceforum.com</a>
30-3 Nov.	<b>ADIPEC</b>	ABU DHABI	<a href="http://www.adipec.com">www.adipec.com</a>
NOVEMBER			
TBC	<b>Leadership Excellence Awards &amp; Symposium</b>	MANAMA	<a href="http://www.lewa-symposium.org">www.lewa-symposium.org</a>
DECEMBER			
TBC	<b>Middle East Bottom of the Barrel Conference</b>	MANAMA	<a href="http://www.europetro.com/events">www.europetro.com/events</a>

Readers should verify dates and location with sponsoring organisations, as this information is sometimes subject to change.

### ADIPEC 2022 Executive Committee meeting highlights priorities for upcoming show

**CHRISTOPHER HUDSON, PRESIDENT, dmg events, discusses some of the key takeaways from the recent ADIPEC 2022 Executive Committee meeting.**

“ADIPEC has been at the heart of the energy industry since 1984. Our mission has evolved over almost three decades, and today, we are driven by the dual goal of helping industry to deliver the energy needs of today whilst investing in the energy systems of tomorrow.

“To help us to achieve this, the makeup of our Executive Committee has also evolved. This year we have expanded the committee to engage new voices and new perspectives from across the energy mix, such as the Environmental Defense Fund, and International Renewables Energy Agency. As a result, ADIPEC is better placed than ever to reflect the priorities and goals of the entire industry as it helps enable a pragmatic and progressive energy transition.

“At the Executive Committee meeting, we discussed the need for ADIPEC 2022 to provide critical insights into geopolitical trends and responses to the energy security challenges. It must also demonstrate industry action and innovation that is driving decarbonisation and explore new energy solutions, as well as tackle the new management agenda, and the future of the industry workforce in a transitioning energy landscape.

“The meeting stimulated a lot of creative thinking and the consultation helps ensure ADIPEC continues to be an event for the industry, by the industry. I would like to extend my personal thanks to ADIPEC chair



Image Credit : dmg events

**Tayba Al Hashemi**, CEO ADNOC Sour Gas, who is returning after overseeing a successful ADIPEC 2021; **Fatema Al Nuaimi**, CEO ADNOC LNG and ADIPEC Awards chairperson; and **Mohamed Al Marzouqi**, SVP Development Function, ADNOC and ADIPEC Technical Programme Committee chairman. Their efforts have been vital in ensuring that ADIPEC remains the world's pre-eminent energy transition platform, convening industry leaders and decision makers to shape the future of the industry.

“ADIPEC 2022 will aim to drive change across the sector – to showcase action and implement promises. Decarbonisation and climate action will be at the heart of the agenda. We will invite leaders from across the industry and beyond to join our dedicated Decarbonisation programme and discuss topics such as methane, CCUS, new energies, and hydrogen.

“In tandem with energy security, we will discuss energy equity, focusing on the importance of finding solutions to the energy trilemma that ensure economies remain competitive and, most importantly, that the developing world is not left behind. As the challenges and needs of different regions vary, so must our proposed solutions.

“ADIPEC 2022 will engage a more global and diverse audience than ever before. We will seek insights from across the energy value chain, as well as from the young minds who will be driving change in the industry for years to come.

“ADIPEC 2022 will champion investment, facilitate cross-industry collaboration, and showcase the innovation driving the future of energy. Join us in Abu Dhabi, from 31 October-3 November 2022. See the website at [www.adipec.com](http://www.adipec.com) for further information.”

## SOGAT 2022 to focus on natural gas decarbonisation

NATURAL GAS IS the cleanest of the fossil fuels, as well as one of the most suitable to be paired with carbon capture, making gas processing a key to the energy transition.

However, GCC gas resources are predominantly sour, with high percentages of H<sub>2</sub>S and CO<sub>2</sub>, requiring stringent conditioning before infrastructure usage. In turn, the processing of the contaminated resources adds to carbon management concerns.

These issues are central themes of SOGAT 2022, which takes place from 5-8 September 2022 in Abu Dhabi. For example, ADNOC's Shah gas plant has the potential to capture 2.3mn tonnes per year of CO<sub>2</sub> and their Habshan and Bab plants almost two million tonnes of CO<sub>2</sub> per year. In fact by 2030, ADNOC aims to expand its CCUS capacity by 500%, capturing five million tonnes of CO<sub>2</sub> per year.

Carbon capture technology is vital internationally, as CO<sub>2</sub> emissions need to decrease by 50% to achieve global climate goals. Thus the SOGAT conference presentation from RATE on a new process combining membranes with liquefaction, providing significant advantages in CO<sub>2</sub> removal from natural gas, will be of particular interest. Also featured will be a novel approach from Saudi Aramco for simultaneous acid gas enrichment and CO<sub>2</sub> capture, where the new process combines membrane and amine technologies to achieve unprecedented levels of H<sub>2</sub>S enrichment and efficient CO<sub>2</sub> capture.

In the exhibition, SOGAT's gold sponsor, FTV Proclad will be featuring their mechanically lined pipe product that has been purposely designed for dynamic steel catenary risers application for sour service



Image Credit: Dome Exhibitions

SOGAT will provide a forum to discuss the latest sour gas processing and treatment technologies.

conditions, and its technical benefits will be presented in the conference. Similarly HIMA are also exhibiting and will be talking about digitalising the safety lifecycle in sour gas applications with a TÜV-certified software platform that digitalises the verification process, enabling the owner to drive down CAPEX and OPEX.

SOGAT 2022 is not only a one-stop shop to learn about and debate the latest findings in sour processing management, but also the event to facilitate in-person business.

Find out more at [www.sogat.org](http://www.sogat.org)

**GCE-SERVICE GmbH**  
Global Consulting and Energy Services

**SPANCHEM TECHNOLOGIES**

**We specialize in**

- ▶ Chemical Cleaning
- ▶ Oil Flushing
- ▶ Silent Steam Blowing
- ▶ Online Furnace Cleaning
- ▶ Refinery Decontamination
- ▶ Hydro-Jetting
- ▶ Hydrotesting

We have a presence in *Algeria, Bahrain, Philippines, Kuwait, Saudi Arabia, South Africa, Serbia, Turkey, UAE*  
In partnership with Furnace Solutions France for online Furnace Cleaning services.

We are currently open for partnerships in CIS region and Qatar.

Email : [partners@spanchem.com](mailto:partners@spanchem.com)  
Web : [www.spanchem.com/partners](http://www.spanchem.com/partners)  
[www.gce.services](http://www.gce.services)

India HQ : +91 93235 93572  
Germany HQ : +49 172 7972064

# Coming together to drive forward health & safety

The renowned MENA HSE Forum returns to Dubai in September, featuring the leading lights of health and safety from the region's foremost companies and organisations.

**A**T THE SEVENTH edition of the MENA Health, Safety & Environment Forum, taking place at the Grosvenor House, Dubai from 6-7 September 2022, decision makers from key sectors such as oil and gas, construction and tourism, along with regulatory authority representatives and industry experts, will convene to network and discuss critical HSE issues.

Through a blend of panel sessions, presentations, workshops, interactive meeting opportunities, and more, attendees will receive insights on all the latest HSE trends and critical new technology, network with peers and industry partners, meet expert suppliers and industry bodies and lay the groundwork to achieve the fundamental HSE targets that matter most to the region. ADNOC, Petrofac, AMAALA, Dubai Municipality, EGA, Saudi Aramco, Abu Dhabi Waste Management Centre – Tadweer and Dubai Holding among others, will deliver keynote presentations to more than 200 stakeholders from the HSE community in UAE, Saudi Arabia, Qatar, Oman and Bahrain.

## Conference agenda

The conference agenda will comprise five sessions:

- Role of HSE leadership in crisis and business continuity management
- Future of digitalisation in the HSE sector
- Process safety and its framework
- Learning from the pandemic and other global transformations about occupational health and behavioural safety
- Sustainable value creation: how ESG moved from a cost centre to a value driver.

Two exclusive breakout workshops will cover the formulation of resilient safety cultures, and digital transformation – from strategy to execution.

Speakers set to present at the MENA HSE Forum 2022 include Tahir Azhibek, corporate HSE manager, ADNOC; Dr Naseem Mohammed Rafee, director of health and safety department, Dubai Municipality; Eng Raed Mohammed Al-Marzooqi, manager of



Image Credit : Alain Charles Publishing

The MENA HSE Forum will provide a platform to share ideas and best practice on critical HSE topics.

“ This is a premier opportunity to build new relationships and network in person with the MENA HSE fraternity.”

studies and system section, health and safety department, Dubai Municipality; Dr Eng Hani Hossni, EHS director, Abu Dhabi Waste Management Centre, Tadweer; Porchelvan Nadanam, corporate manager HSE, Arabian Industries Projects; Salman Abdulla, executive vice president, EHSQ & Sustainability, Emirates Global Aluminium; Dr Essam Hassan, senior environmental consultant, Egyptian Environmental Affairs Agency and KGESS; Saleh Ali Al Balushi, HSE director,

Dubai Holding Asset Management; and Azam Soukar, director group HSE, Dubai Holding Entertainment.

Vinay T, head of Business Development at Alain Charles Events, commented, “Our research with stakeholders from the oil & gas, construction and tourism sectors revealed that end users are seeking disruptive technologies that will continue to cut LTI and optimise productivity.

“We identified a need to access latest safety solutions for workforce across the board which led us to create this exclusive platform for HSE companies to display and demonstrate their services and solutions to key players in the region. This is also a premier opportunity to build new relationships and network in person with the MENA HSE fraternity.” ■

Please register for the HSE Forum at <https://www.hseforum.com/mena/register>

# Effective process safety management

In advance of the MENA HSE Forum, Dr. Eng. Hani Hossni, EHS director, Abu Dhabi Waste Management Center (Tadweer), discussed Tadweer's approach to safety management.

## What are the main process safety hazards you face at Tadweer?

The main safety hazards in waste management result from the improper handling of hazardous waste, which might cause harm to human health. To minimise such risks, the UAE government has launched major initiatives to handle waste management, which include recycling, converting waste to energy and resources, utilising new technologies, and improving waste separation and collection systems. This limits the risks that might result from improper waste disposal.

## What are the most important factors for delivering a successful and effective process safety management programme?

Complying with regulatory requirements is key for delivering a successful and effective process safety management programme. At Tadweer, we ensure we adhere to the highest local and international standards in health, safety, and environment management. During our operations, we ensure we are safeguarding the health, safety and welfare of our employees and the public, and ensure that our operational activities are effectively controlled with regard to the protection of the environment.

Tadweer's Occupational Safety and Health (OSH) policy highlights the importance of putting preventive measures in place to avoid and mitigate occupational health and safety risks. It also outlines the company's commitment to reviewing, monitoring, evaluating and improving our OSH performance.

Challenges in EHS management include pollution and excessive noise, improper handling of material, health issues, and more. At Tadweer, we develop the required systems for managing waste including collection, transport, treatment, safe disposal and pest control services through the use of environmental service providers and technology, to preserve the environment.

We have also set a list of health and safety requirements for our contractors, to limit any



Image Credit : Tadweer

Dr. Eng. Hani Hossni, EHS director, Tadweer.

potential risks caused by waste management. For example, the contractor and subcontractors are required to supply all workers with the personal protective equipment (PPE) needed to protect them from any potential risks. In addition, all workers on site must attend an EHS induction by the contractor. We make sure that all our contractors comply with our EHS requirements, through controlling noise, displaying safety signage, having storage for hazardous material, and preventing pollution.

## What do you think is the role of technology in promoting safe and efficient operations?

Tadweer is keen to invest in the latest technological advancements that maximise efficiency and promote safety. The Center has provided a wide range of electronic services. These services include providing all recycling services on the Unified Digital Platform (TAMM), providing an access feature using digital IDs, linking with the SADAD Payment System, linking with the Abu Dhabi Department of Health through digital documentation services, as well as providing a dashboard to reduce waste production, and a new version of the licensing and tariff system.

Last year, we introduced Internet of Things (IoT) technology at the construction and demolition waste recycling station in the Al Dhafra region of Abu Dhabi, a first-of-its-kind step in the Middle East. The implementation of this technology increases operating time to the maximum limit, while also improving energy efficiency by smart remote movement sensors, which will monitor the station's assets and machinery. The internet has also allowed the incorporation and use of iAuditor application which is a comprehensive solution for carrying out inspection, monitoring the findings, assigning actions, and is interlinked to the department members' email identification for the ease of analysing and tracing.

## How important is it to instill a good safety culture and ensure employee engagement?

As part of our strategic plan, Tadweer is promoting a sound health and safety culture among its various stakeholders. We identify, study and evaluate the applicable industry best practices and are continuing to identify challenges develop roadmaps and review both improvement and development strategies and best practices in the field of occupational safety and health.

Last year, the Center achieved a compliance rate of 95% of its occupational safety and health management system in line with the requirements of the Abu Dhabi Occupational Safety and Health System in 2021. This achievement came after the completion of the project for the development of Tadweer's occupational safety and health management system, as well as playing the role of Regulator for the waste sector in the Emirate of Abu Dhabi; this covers 146 entities comprising 100 low and medium-risk entities, and 46 high-risk entities, with a total of approximately 23,000 employees. The Center also completed an employee training plan for environment, health, safety, and business continuity, recording a total of 3,300 training hours in the waste sector during 2021. ■

## Mitsubishi Power signs contract with ANRPC

MITSUBISHI POWER HAS signed a full turnkey contract with Egypt's Alexandria National Refining & Petrochemicals Company (ANRPC) to provide advanced hydrogen fuel conversion technology solutions, supporting the company to achieve its decarbonisation goals. The solution will be installed at the ANRPC refinery plant in Alexandria, which provides 30% of Egypt's gasoline supply for domestic consumption.

Mitsubishi Power will be responsible for the design, engineering, procurement, construction and commissioning of fuel conversion solutions for the existing 100 ton/hour boiler, enabling it to fire up to 100% hydrogen by the end of 2023. This includes the installation of state-of-the-art hydrogen burner technology and advanced control solution to ensure efficient and safe operations.

Salah Gaber, chairman & CEO of ANRPC, said, "We are thrilled to partner with world technology leader Mitsubishi Power on innovative fuel conversion solutions that will help us to achieve our commercial goals while reducing our carbon footprint by 22,000 tons annually. Modernising existing conventional boilers by enabling fuel conversion is a practical and important milestone to enable Egypt to deliver on its ambitious energy efficiency and decarbonisation goals under the national Integrated Sustainable Energy Strategy."



The signing ceremony.

Image credit: Mitsubishi Power

## eDrilling teams up with EROG in Saudi Arabia

EDRILLING, A LEADING supplier of AI, machine learning, and predictive analytics solutions to the energy industry, and EROG - Earth Reservoir for Oil & Gas, a leading provider of services in the Kingdom of Saudi Arabia, have teamed up to help E&P companies optimise their well construction workflows and processes for greener, safer and more efficient energy operations.

Combined with eDrilling's AI and machine learning-powered software, the two companies will offer an all-encompassing solution for operators in the region, to help them better plan, prepare for, perform and optimise drilling operations.

"Together with EROG, we are committed to helping customers in the region improve their well construction performance and support them in their adaption towards utilising greener technologies. With EROG's promise to address industry challenges through advanced technology, our cooperation will be a valuable offering for energy companies," said Alina Sundalskleiv, sales & marketing manager of eDrilling.

EROG provides services to the oil and gas industry to improve cycle time and optimise production of oil and gas wells.

## Schlumberger and Subsea 7 renew alliance

SCHLUMBERGER AND SUBSEA 7 have signed an agreement to renew their Subsea Integration Alliance for a further seven years.

Subsea Integration Alliance is a worldwide non-incorporated alliance between Subsea 7 and Schlumberger's OneSubsea subsea technologies, production and processing systems business, to jointly design, develop and deliver integrated subsea development solutions through the combination of subsurface expertise, subsea production systems (SPS), subsea processing systems, subsea umbilicals risers and flowlines systems (SURF), and life-of-field services.

"The success of Subsea Integration Alliance is a result of the drive and commitment of both Subsea 7 and OneSubsea to deliver an enhanced experience and outcome for our clients," said John Evans, Subsea 7 chief executive officer. "Driven by the demonstrable benefits to clients of this mode of collaborating, integrated projects are expected to remain a significant component of the subsea market. We look forward to extending our relationship with OneSubsea as we address the opportunities of the offshore energy market."

Over the past seven years, the alliance has worked collaboratively with clients to design, develop and deliver integrated SPS and SURF solutions proven to optimise the cost and efficiency of deepwater developments. It has been awarded major greenfield projects in Australia, Brazil, Africa and Turkey, as well as significant tie-back work in the Gulf of Mexico and Norway.



The alliance addresses the opportunities of the offshore energy market.

Image credit: Adobe Stock

## Aramco publishes sustainability report

ARAMCO HAS PUBLISHED its first sustainability report, which outlines ways in which the company plans to further tackle emissions while delivering reliable, affordable energy solutions.

The report's release follows the company's announcement of its ambition to achieve net-zero Scope 1 and Scope 2 greenhouse gas (GHG) emissions across its wholly-owned operated assets by 2050.

By 2035 Aramco aims to reduce its Upstream carbon intensity, already one of the lowest in the industry, by 15% to 8.7kg of CO<sub>2</sub>e equivalent per barrel of oil equivalent (CO<sub>2</sub>e/boe), against a 2018 baseline of 10.2kg CO<sub>2</sub>e/boe.

The company also aims to reduce or mitigate net Scope 1 and Scope 2 GHG emissions across its wholly-owned operated assets, both in its Upstream and Downstream segments, by more than 50 million metric tons of CO<sub>2</sub>e annually by 2035.

Amin H. Nasser, Aramco president & CEO, said, "Our ambition is to achieve operational net-zero by 2050, and our sustainability report highlights how we aim to continue meeting the world's rising demand for secure, reliable and affordable energy, while also contributing to the broader energy transition. We are investing for the long-term, and we will continue to integrate breakthrough technologies in our operations over the next decade and beyond."

Aramco is harnessing the Circular Carbon Economy framework, which focuses on reducing, reusing, recycling and removing GHG emissions. By 2035, it aims to achieve emissions reduction and mitigation through renewables investment; investing in carbon capture, utilisation and storage; energy efficiency improvements; methane and flaring reduction; and offsets.

The report also outlines the company's focus on developing its blue ammonia and hydrogen business, with the aim of producing up to 11mn metric tons of blue ammonia per year by 2030 — with the potential to support significant emissions reductions in hard-to-decarbonise sectors such as heavy-duty transport, heating, and industrial applications.

The sustainability report highlights four focus areas: climate change and the energy transition, safe operations and people development, minimising environmental impact, and growing societal value.

You can download the report at: [www.aramco.com/en/sustainability/sustainability-report](http://www.aramco.com/en/sustainability/sustainability-report)



## Chariot signs FEED agreement for Morocco gas project

CHARIOT, THE AFRICA-FOCUSED transitional energy company, has signed a front-end engineering and design (FEED) agreement with Schlumberger and Subsea 7, as part of a consortium, for the Anchois gas development project in Morocco. Chariot, Schlumberger, and Subsea 7 will continue to adopt a "one-team" integrated and collaborative approach to safely fast-track first gas to maximise the return on investment.

The scope of the Agreement covers:

- Front-end engineering support and design work for the Anchois gas development, incorporating offshore components including well completions, subsea production systems, and subsea umbilicals, risers, and flowlines that will be delivered by Subsea Integration Alliance; and onshore components including a central processing facility (CPF) and flowlines and controls from the CPF to the shore crossing that will be delivered by Schlumberger.
- Generation of deliverables, such as engineering, procurement, construction, installation, and commissioning costs and schedules, required prior to final investment decisions (FID).
- Opportunity for Chariot to directly source EPCIC services with Schlumberger and Subsea 7 for the field development and operations and maintenance of the facilities during commissioning and the early production phase.
- Commitment to environmental, social, and governance (ESG), minimising emissions and contributing to social development through the creation of direct and indirect jobs in Morocco.

Beyond this Agreement, Chariot is managing the additional FEED scopes required for the development, including well construction and onshore infrastructure, including fixed pipelines, to deliver gas to customers.

Adonis Pouroulis, acting CEO, Chariot Limited, commented, "Signing this agreement with Schlumberger and Subsea 7 is further evidence that we have accelerated development plans for the Anchois Gas Project.

"We look forward to building on this relationship and to realise the benefits of an integrated project execution. Reduced interfaces, fewer contingencies, and strong leverage over procurement and the offshore construction schedule will help shorten time to first gas. This streamlined approach will benefit all stakeholders, which is a key objective of fast-tracking the project towards cashflow."

## IEA forecasts 8% rise in energy investment in 2022, driven by clean energy



The growth in energy investment is forecast to come mainly from clean energy.

Image credit: Adobe Stock

GLOBAL ENERGY INVESTMENT is set to increase by 8% in 2022 to reach USD 2.4 trillion, with the anticipated rise coming mainly in clean energy, according to a new report by the International Energy Agency (IEA).

The fastest growth in energy investment is coming from the power sector – mainly in renewables and grids – and from energy efficiency, according to the IEA's *World Energy Investment 2022* report. The rise in clean energy spending is not evenly spread, however, with most of it taking place in advanced economies and China. And in some markets, energy security concerns and high prices are prompting higher investment in fossil fuel supplies, most notably on coal, with a 10% rise in investment in coal supply in 2021, led by emerging economies in Asia.

"We cannot afford to ignore either today's global energy crisis or the climate crisis, but the good news is that we do not need to choose between them – we can tackle both at the same time," said IEA executive director Fatih Birol. "A massive surge in investment to accelerate clean energy transitions is the only lasting solution. This kind of investment is rising, but we need a much faster increase to ease the pressure on consumers from high fossil fuel prices, make our energy systems more secure, and get the world on track to reach our climate goals."

Since 2020, clean energy investment has accelerated significantly, with renewables, grids and storage now accounting for more than 80% of total power sector investment. Spending on solar PV, batteries and electric vehicles is now growing at rates consistent with reaching global net zero emissions by 2050.

However, tight supply chains are also playing a large part in the headline rise in investment. Almost half of the overall increase in spending is a reflection of higher costs, from labour and services to materials such as cement, steel and critical minerals. These challenges are deterring some energy companies from accelerating spending.

From a low base, there is rapid growth underway in spending on some emerging technologies, notably batteries, low emissions hydrogen, and carbon capture utilisation and storage. Investment in battery energy storage is expected to more than double to reach almost US\$20bn in 2022.

Much more needs to be done to boost energy investment in emerging and developing economies, according to the IEA, to bridge widening regional divergences in the pace of energy transition investment.

The IEA notes that Russia's invasion of Ukraine has pushed up energy prices across the world. Some of the immediate shortfalls in exports from Russia need to be met by production elsewhere, notably for natural gas, and new LNG infrastructure may also be required to facilitate the diversification of supply away from Russia. While oil and gas investment is up 10% from last year, it remains well below 2019 levels.

Today's high fossil fuel prices are generating pain for many economies, but are also generating an unprecedented windfall for oil and gas producers. Global oil and gas sector income is set to jump to US\$4 trillion in 2022, more than twice its five-year average, with the bulk of it going to major oil and gas exporting states.

These windfalls gains provide a once-in-a-generation opportunity for oil and gas producing economies to fund the much needed transformation of their economies, and for major oil and gas companies to do more to diversify their spending, the IEA says. The share of spending by oil and gas companies on clean energy is rising slowly, with what progress there is driven mainly by the European majors and a handful of other companies. Overall, clean energy investment accounts for around 5% of oil and gas company capital expenditure worldwide, up from 1% in 2019.

## Hydrogen: the energy transition's missed opportunity?

UPTAKE IN ADOPTING hydrogen as a crucial player in decarbonising the world's energy system may be too slow to make adequate impact, as a new report by DNV urges governments to make urgent and significant policy interventions.

In *Hydrogen Forecast to 2050*, DNV predicts the proportion of hydrogen in the world's energy mix will only reach 0.5% by 2030 and 5% by 2050. To meet the demands of the Paris Agreement, global uptake would need to triple that and meet 15% of energy demand by the mid-century.

"Hydrogen is essential to decarbonise sectors that cannot be electrified, like aviation, maritime, and high-heat manufacturing and should therefore be prioritised for these sectors," said Remi Eriksen, group president and CEO of DNV.

"Policies do not match hydrogen's importance. They will also need to support the scaling of renewable energy generation and carbon capture and storage as crucial elements in producing low-carbon hydrogen."

The report predicts that electricity-based green hydrogen, produced by splitting hydrogen from water using electrolyzers, will prevail as the dominant form of production by the middle of the 21st century, accounting for 72% of the world's hydrogen output. To achieve such levels, a surplus of renewable energy is required to power an electrolyser capacity of 3,100 gigawatts – more than twice the total installed generation capacity of solar and wind today.

Global spend on producing hydrogen for energy purposes through 2025 is expected to hit US\$6.8tn, along with an additional US\$180bn spent on hydrogen pipelines and US\$530bn on building and operating ammonia terminals, according to DNV's forecasts.

"Scaling hydrogen value chains will require managing safety risk and public acceptance, as well as employing policies to make hydrogen projects competitive and bankable. We need to plan at the level of energy systems, enabling societies to embrace the urgent decarbonisation opportunities presented by hydrogen," concluded Eriksen.



*Hydrogen could be a crucial player in decarbonising the world's energy system.*

Image credit: Adobe Stock

## ADNOC identifies US\$19bn local manufacturing potential

THE PRIVATE SECTOR is being urged to seize opportunities in local manufacturing as the Abu Dhabi National Oil Company (ADNOC) announces it has identified AED70bn (approximately US\$19bn) worth of products in its procurement pipeline which could be manufactured locally.

Of this value, ADNOC has signed agreements worth US\$5.7bn with UAE and international companies at the Make it in the Emirates Forum, which took place in Abu Dhabi. These contracts will see ADNOC and its partners set up and expand manufacturing facilities, as well as explore the potential for new investments.

Opportunities in local manufacturing comprise over 100 products to be utilised across ADNOC's full value chain as it eyes operational expansion to cater for the growing global energy demand.



Image Credit: ADNOC

*ADNOC is also driving industrial growth with the expansion of its downstream business.*

The company's purchase of these products is currently aimed to be completed between 2022 and 2030.

H.E. Dr. Sultan Ahmed Al Jaber, UAE Minister of Industry and Advanced Technology and ADNOC managing director and group CEO, said, "ADNOC is reinforcing its role as a critical engine for the UAE's industrial growth as we expand our operations to cater for the world's growing energy demand. In line with the UAE Leadership's wise directives and our national industrial strategy, ADNOC is creating multiple long-term domestic manufacturing opportunities for the private sector. We invite manufacturers to join the UAE in our industrial growth journey as we strengthen the resilience of our supply chains."

The products with local potential span drilling; mechanical and heating ventilation and air conditioning; technology; piping; fittings and valves; electric submersibles; instruments, control and telecoms; maintenance, repair and operations; chemicals; electrical; and offshore architecture.

## Middle East set for growth despite worldwide pressures

THE LATEST ECONOMIC insight report for the Middle Eastern region, commissioned by ICAEW and compiled by Oxford Economics, reveals a positive outlook on the region's growth, despite a darkening global landscape with pressure and uncertainty mounting.

Middle East GDP growth for the year ahead (2022) is now projected at 5.2% – an increase of 1% from Oxford Economics' forecast released earlier in the year.

According to the report for Q2, Middle Eastern countries are under pressure from the ongoing Russia-Ukraine conflict, China's economic slowdown as lockdowns persist and global market conditions tightening.

The rise in oil prices has, however, given a much-needed boost to the Gulf's macroeconomic environment, offsetting the complex impact of rising inflation and supply chain disruptions. The potential for recession could weigh on oil demand and test the GCC's resilience.

GDP growth prospects in Saudi Arabia have been improved by inflated oil prices, where the forecast has brightened from 4% to 7.1%. In the UAE, government reform agendas and growing oil output are expected to underpin the year's growth of 6.7%. Higher income from hydrocarbons will likely mean all six GCC nations will have post-budget surpluses, despite rising costs.

Vanessa Heywood, ICAEW head of Middle East, said, "The Middle East is faced with an interesting dilemma. Geopolitical turmoil has brought the GCC nations to the international negotiating table to aid global oil supply challenges. While inflated energy prices will support its renewable energy transition, the region's leadership has demonstrated resistance to delaying the progress being made in its energy transition, even as global pressures mount."



31 October - 3 November 2022

Abu Dhabi, United Arab Emirates

Supported By



# DRIVING SMART, SUSTAINABLE AND RELIABLE ENERGY SYSTEMS

## ADIPEC IN NUMBERS

54

NOCs, IOCs, NECs and IECs

28+

Exhibiting International Country Pavilions

1,200+

Speakers

350+

Conference Sessions

2,200

Exhibiting Companies

150,000

Energy Professionals

12,000

Conference Delegates

140,000

Gross Sqm



I look forward to welcoming my fellow ministers to Abu Dhabi and ADIPEC, as well as the global energy industry, with whom UAE shares a common goal of diversifying the energy mix to reach our climate ambitions. The critical discussions that will take place at ADIPEC 2022, around the role of oil and gas in the energy transition, are even more important as we pivot to cleaner forms of energy and reduce our carbon footprint. "

**His Excellency**  
**Suhail Mohamed Faraj Al Mazrouei**  
 Minister of Energy and Infrastructure  
 United Arab Emirates



## 3 WAYS TO BOOK YOUR STAND

1 CONTACT US ON:  
 +971 2 444 4909

2 EMAIL US AT  
 adipec.sales@dmgevents.com

3 SCAN THE QR CODE  
 TO FIND OUT MORE



f in t o i

#ADIPEC  
 #ADNOC  
 @ADIPECOFFICIAL

[www.adipec.com/bookstand](http://www.adipec.com/bookstand)



ExxonMobil



Partners



Gold Sponsors

Host City



Venue Partner



Strategic Insights Partner



Technical Conference Organised By



ADIPEC Brought To You By



## QatarEnergy and TotalEnergies partner in NFE expansion project

QATARENERGY HAS SELECTED France's TotalEnergies as its first international partner in the North Field East (NFE) LNG expansion project, designed to increase Qatar's total LNG export capacity from 77 Mtpa to around 110 Mtpa by 2027.

TotalEnergies has been awarded a 25% interest in a new joint venture (JV), alongside QatarEnergy (75%). The new JV in turn will hold a 25% interest in the 32 million tonnes per annum (Mtpa) NFE project, equivalent to one 8 Mtpa LNG train.

The NFE, launched by QatarEnergy in summer 2019, is currently under construction. The upstream part of the project will develop the southeastern area of the field with eight platforms, 80 wells and gas pipelines to the onshore plant. With a focus on environmental and climate challenges, the project will apply the highest standards to reduce emissions. The native CO<sub>2</sub> from natural gas production will be captured and sequestered in a saline aquifer.

QatarEnergy has since also signed partnership agreements with Eni, ExxonMobil and ConocoPhillips.



The signing of the partnership with TotalEnergies.

Caption: QatarEnergy

## Norwell secures UAE contract to deliver first integrated decommissioning project

NORWELL ENGINEERING, A global well engineering and project management firm, has secured a multi-million dollar contract to deliver an integrated offshore decommissioning project in the UAE on behalf of operator Sinochem Corporation (Sinochem).

Norwell Engineering will develop the abandonment strategy for Sinochem's UAQ gas field as well as detailed well and facilities decommissioning planning, tendering and procurement services, logistics, marine support and operational execution.

Mike Adams, general manager of Norwell Engineering, said the company partners with client decommissioning teams to address technical, safety, environmental and legislative considerations. He commented, "While the decommissioning sector is heating up with several well engineering firms active in the space, our experience and technical focus across the entire field provide operators with a different perspective – reducing risks and identifying efficiency savings during every phase."

## ADNOC L&S acquires new-build vessels to meet growing LNG demand

ADNOC LOGISTICS & Services (ADNOC L&S), the shipping and maritime logistics arm of the Abu Dhabi National Oil Company (ADNOC) and one of the region's largest shipping and logistics companies, is set to purchase three additional LNG vessels.

The new-build LNG vessels, each with a capacity of 175,000 cu m, are significantly larger than the current ADNOC L&S fleet which has a capacity of 137,000 cu m each. ADNOC L&S previously announced in April 2022 that it will acquire two LNG vessels, which brings the total number of new-build LNG vessels ordered to five, with the vessels scheduled for delivery in 2025 and 2026.

All five new-build LNG vessels will be built at the Jiangnan Shipyard in China. Jiangnan Shipyard was also previously commissioned by ADNOC L&S in 2020 to build five Very Large Gas Carriers (VLGC) for AW Shipping, ADNOC L&S' Joint Venture company with China's Wanhua Chemical Group.

The acquisition of larger, more energy-efficient vessels will allow ADNOC L&S to meet growing customer demand while improving the environmental footprint of its fleet. The new vessels' engine technology will reduce emissions (CO<sub>2</sub>, NO<sub>x</sub> and SO<sub>x</sub>) and in combination with the innovative air lubrication system, further reduce fuel consumption by at least 10%.



The vessels will feature technology for higher efficiency and reduced emissions.

Caption: ADNOC Logistics & Services

## STATS Group expands further in the Middle East

PIPELINE TECHNOLOGY SPECIALIST STATS Group has added more staff to its Middle East operations as the result of a post-Covid uptick in project activity.

The Middle East was one of the strongest performing regions for the company in 2021, with revenues increasing from US\$9.6mn in 2020 to US\$14.2mn.

In the Saudi Arabian market, the company strengthened its position with the award of a major subsea intervention project, and STATS plans to increase its local presence in the Kingdom to support further growth.

In addition to securing a swathe of new contracts in UAE, Qatar, Kuwait and KSA, STATS has extended its Master Service Agreement with Petroleum Development Oman (PDO) for the provision of pipeline



Caption: STATS Group

STATS Group is strengthening its presence in the Middle East.

isolation and hydrostatic testing services for a further five years.

STATS is also conducting what is believed to be the world's largest diameter subsea pipeline intervention campaign on behalf of a Middle East client, which involves the hot tapping and isolation of 10 pipelines with diameters ranging from 42" to 56".

The company has relocated Dale Millward, one of its most experienced pipeline intervention experts to Doha as vice president technical assurance, in response to the increased demand for STATS products and services, as Qatar makes significant investment in its LNG production facilities. The business has also appointed two business development engineers in Oman and Saudi Arabia. Employing more than 80 staff in the Middle East at bases in Abu Dhabi, Oman and Qatar, the company is looking to recruit additional technicians and engineers to support its activities across the Gulf region.

## Wood Mackenzie highlights impact of Russian invasion on energy trade flows and energy transition

WAR IN UKRAINE is transforming the outlook for the supply, demand and price of hydrocarbons and the pace and cost of the energy transition, says Wood Mackenzie, a Verisk business.

While the precise timing and implementation of future bans on Russian commodity imports are difficult to predict, a rewriting of energy trade flows is now underway.

With the global economy on a knife edge and energy prices structurally higher, there is a real risk of some global supply being lost. Europe's push for more LNG as it looks to reduce Russian pipeline gas has pushed spot prices to record levels and is supporting strong demand for coal. At the same time, supply-chain risks are growing, and inflation is increasing costs across the energy sector.

Against this backdrop and with coal currently more resilient, further advancing the energy transition could be more expensive and potentially prove more carbon intensive, says Wood Mackenzie.

Massimo Di-Odoardo, vice president of gas and LNG research at Wood Mackenzie, said, "While prices will be structurally higher and a ban on Russian gas will be more challenging than that of other commodities, the 'west' can live without Russian commodity exports and we are already seeing a new trade balance taking shape. Increasing domestic coal production in China and India will compensate lower seaborne availability. While perhaps the biggest risk to Russian oil production is in the long term and relates to the loss of access to western partners, technologies and services."

The research by Wood Mackenzie emphasises that a future ban on Russian gas will see competition for LNG intensifying, as Europe competes with Asia for limited supply growth through to around 2026.

"A huge increase in LNG project investment



Image Credit: Adobe Stock

*Competition for LNG is set to intensify.*

is being supported by a rapid increase in European LNG demand, with US developers already looking to fill the space," said Di-Odoardo. "As a result, there is a potential for 50 million tonnes per annum of new US LNG capacity that will take final investment decisions over the next two years – and this could double if Europe bans imports from Russia by 2024."

Di-Odoardo further commented, "But despite disruptions to Russian exports, global supply chains are now emerging as the biggest concern. Rising costs could delay investment in necessary energy supply and delay the pace of investment in clean energy needed to meet decarbonisation goals.

"The most successful governments, companies and investors will be those who best navigate these complex market conditions to accelerate the energy transition."

Wood Mackenzie's says that countries with domestic hydrocarbon and critical mineral resources will need a twin-track approach: maximising production of their resources in the short term while stepping up investment in low-carbon energy supply to meet future demand in the long term.

For investors, energy transition investment

will be more expensive but remains competitive due to higher commodity and power prices. European renewables will increase rapidly. Energy security priorities will ensure returns remain attractive for hydrocarbons and, increasingly, critical infrastructure. LNG looks the most attractive investment option, but even that could prove limited in time if Europe and other countries accelerate on net zero goals.

For companies, hydrocarbons will be tremendous money spinners for some time to come. Attractive opportunities for low-cost, low-carbon supply of oil and gas from the national oil companies (NOCs) will continue. But large-scale investment by international oil companies (IOCs) in traditional oil and gas projects, as well as international mining companies in coal projects, will increasingly be displaced by growing investment in low-carbon energy projects. Metals could be the next growth areas for cash-rich IOCs.

Some European governments have already accelerated their decarbonisation strategies in response to the war. Others will follow, along with increased policy support for investment in the emerging technologies needed to accelerate the energy transition.

But this is heaping pressure on already stretched global supply chains, with renewable costs already being driven up. We are also seeing a scramble for the metals to build out electrification, potentially compounded by reduced exports from Russia.

There is also a risk that an accelerated energy transition could prove more carbon intensive. But Wood Mackenzie's analysis shows that upward pressures on emissions will likely be offset by the slower economic growth and renewed focus on low carbon investments, with CO<sub>2</sub> emissions reducing by up to 15% by 2035, compared with 2021.

**MABI Insulation machinery**  
Simplify your workflow







MABI AG - Insulation machinery - Weidstrasse 10 - CH-5100 Veltheim / Switzerland

**The MABI Bingo 2 EVO**  
equipped with technical finesse.  
Experience the full spectrum of  
innovative sheet metal processing...

With integrated pipe production  
of the MABI Bingo 2 EVO up to 8  
pieces ready-to-install pipe meters  
per minute.



info@mabi.ch

www.mabi.ch

Swiss Made 

# Navigating a path through the energy transition

Petroleum Development Oman (PDO) celebrates its 85th anniversary this year and looks in better shape than ever, but there is no doubt the company has its eyes fixed firmly on the future. Martin Clark reports.



Image Credit : PDO

*The Yibal Khuff project will help meet Oman's growing oil and gas demands.*

**D**ESPITE THE HUGE transformations facing the energy sector globally, Petroleum Development Oman (PDO) continues to look to the future with great confidence. This year, the company celebrates its 85th anniversary, after its foundation back in 1937.

PDO has long defined Oman's own energy production, accounting for the vast majority of its oil and gas output – it exported its first oil 55 years ago in 1967 – but now steers a path to alternatives and other options, including hydrogen, as the Sultanate prioritises sustainability and carbon reduction initiatives.

Speaking at the 14 May, 2022 'PDO Day' event, managing director Steve Phimister outlined the company's illustrious history and pledged to build on those solid foundations "as we enter a new era and capture the

opportunities that come with the energy transition". He also promised "exciting times ahead", as PDO evolves into a fully integrated energy company.

"In full alignment with the Oman Vision 2040, we will grow our core hydrocarbon business and develop new low-carbon value chains, thereby sustaining our contribution to Oman for decades to come."

“ Daily average production of crude oil increased to 1.04mn bpd during Q1 2022.”

Indeed, despite the rapid pace of change worldwide, economies both near and far need to be supported by consistency, with traditional energy production still integral to daily operations.

That means Oman's current production rates are flying high following a period of sustained investment and activity on the ground. Its daily average production of crude oil increased to 1.04mn bpd during the first quarter of 2022, up by 8.7% on the same period of last year, with total oil exports growing by 18% during the first three months of 2022. Inflated prices also meant that net oil revenues climbed 81% year on year to 1.09bn riyals during the first two months of this year.

As such, PDO, and other energy companies in Oman, continue to spend in order to boost hydrocarbons production. A

few months ago, it unveiled the ambitious Yibal Khuff project (YKP), its second largest ever, with a production of 5mn cubic metres of gas and 20,000 barrels of crude oil per day (bpd) when fully operational. It introduces the first sour oil to the YKP Central Processing Facility, with the project already now exporting crude oil to the Main Oil Line. Spanning an area of 1.68 sq km, YKP is also perhaps the most technically complex project in PDO's history, reflecting the company's increasing sophistication and engineering excellence. The project will help towards meeting Oman's growing medium and long-term oil and gas demands, as well as reducing PDO's net non-associated gas import.

### Made in Oman

One of the prime international contractors to work on the scheme was Petrofac, which was awarded the engineering and procurement work for the project in 2015. But YKP also provided a rich stream of opportunities for local enterprises, reflecting the government's ongoing, strategic 'Omanisation' drive. Around US\$400mn in contracts were awarded to Omani companies for the provision of goods and services under the project.

YKP also achieved several significant firsts, including the delivery of the tallest column ever fabricated for PDO in Oman. This 'Made in Oman' acid gas recovery unit absorber stands at 48 metres high, four metres in diameter, and weighs 291 tonnes. The project also delivered one of PDO's first steam turbine generators, taking the heat from some of the facilities' processes and using it to generate steam. The plant will be able to generate 13 megawatts (MW) of electrical power, supplementing the 45MW of the Yibal Khuff Power plant.

Separately, PDO recently recognised three Omani service partners, signing contract extension agreements with several so-called Super Local Community Contractors (SLCCs) – Al Baraka Oil Services, Shawamikh Oil Services and Al Sahari Oil Services – for well maintenance services.

This year also marks the 10-year anniversary of the launch of PDO's own In-Country Value (ICV) programme aimed at maximising spending retained in the country

“We are committed to playing a key role in this alliance for hydrogen to drive a pivotal change as we transition to a greener, more sustainable and diversified economy.”



Image Credit : PDO

*PDO is a member of the 'Hy-Fly' alliance to put Oman on the map for the development and deployment of clean hydrogen.*

to benefit local business development. At the same time, international firms continue to play a vital supporting role in the emergence of this homegrown expertise.

In the drilling segment, KCA Deutag has recently landed a succession of awards to support activities in the field. Most recently, it reported that two of its highly mobile 2000hp desert rigs had been awarded a total of three firm and four optional years contracts as an extension to existing contracts, worth around US\$80mn. The drilling specialist will also work with PDO on an innovative project to build new rigs in Oman, further highlighting the rise in local industry skills and sophistication. The rigs will be constructed by International Drilling Technology Co. (IDTEC) in Oman, for deployment in the local upstream sector.

### Sustainable future

While work in traditional hydrocarbons accounts for much of PDO's day-to-day work, there is little doubt that deep shifts are taking place simultaneously as the energy transition takes hold. Clean and renewable energy projects are popping up across Oman's desert landscape, as they are elsewhere in the Gulf, plus exploratory work in new areas, such as hydrogen and carbon capture, is accelerating. PDO is teaming up with Shell Development Oman LLC (Oman Shell), for example, to collaborate and jointly study carbon capture utilisation and storage opportunities. This collaboration will kick off with a study to look at possible carbon capture projects in Oman.

Oman's Ministry of Energy and Minerals (MEM) is also establishing a national hydrogen alliance – branded as 'Hy-Fly' – to place Oman on the map for the development and deployment of clean hydrogen, a key element in the energy evolution reshaping the world right now. Hy-Fly is made up of key public and private entities encompassing government bodies, oil and gas operators,

educational and research institutes as well as ports, that reads like a who's who of Oman's energy industry. The list includes PDO, Energy Development Oman, OQ, Oman LNG, BP Oman, Oman Shell and TotalEnergies Oman, Sultan Qaboos University, GUTech, and the ports of Sohar and Duqm.

At a launch event last year, PDO's Steve Phimister highlighted the significance of the move.

“Over time, hydrogen has the potential to help transform the domestic and global energy sector, alter the way we all produce and consume energy, and address carbon emissions locally and around the world,” he said.

“We are committed to playing a key role in this alliance for hydrogen to drive a pivotal change as we transition to a greener, more sustainable and diversified economy, in line with the Oman 2040 Vision.”

### Social investment

PDO continues to maintain a strong commitment to social investment in the wider community. In May, the company announced its support for a host of new initiatives which will benefit communities and boost sustainable development across the Sultanate.

The initiatives cover commitments in the key areas of health, safety and the environment (HSE), community infrastructure development as well as sponsoring several programmes in education, culture and sports. They include funding the procurement of new medical equipment for local hospitals and health centres; sponsoring the installation of solar powered streetlights; sponsoring a study to set a standard for flood protection and mitigation studies and designs through a pilot project targeting Wadi Al Hawasinah that will help in understanding the impacts of climate change; and sponsoring the participation of Oman's Paralympics team in the Asian Games 2022. ■

# Building tomorrow's energy supply

The latest EPC contract activity highlights the massive Gulf energy investment drive, says Martin Clark.

Image Credit : Aramco

*Aramco has provided a steady flow of EPC opportunities.*

**A**S THE WORLD'S leading energy hub, project activity in the Middle East continues apace despite all the uncertainties surrounding the global economy right now.

The war in Ukraine means Russian oil and gas markets have tightened in Europe, which opens potential new opportunities among key Gulf suppliers. This additional responsibility is likely to keep engineering, procurement and construction (EPC) contractors engaged across the Middle East for the foreseeable future.

Energy prices have also risen, driven by soaring inflation after lockdowns, the uptick in demand and more recently the Ukraine crisis.

It means prospects may be more buoyant as the Middle East's national oil companies (NOCs) ramp up capital expenditure in response to elevated pricing.

The world EPC market began the year in a

more subdued fashion, however, although there are already signs of a turnaround – with the Middle East leading the way. While global contract activity was mostly stifled by the Russia-Ukraine conflict during Q1 2022, things picked up in the latter half of the quarter, according to data and analytics group, GlobalData.

“Contracts in the oil and gas industry could only float due to the sheer uncertainties surrounding it, including the ongoing Russia-

“ There is likely to be more to follow as the Saudi oil giant steps up efforts to increase production capacity.”

Ukraine crisis, rising prices, and project cost escalation,” said Pritam Kad, oil and gas analyst.

Yet, there are strong grounds for optimism amid some of the doom and gloom in the news.

In its first quarter 2022 results, announced on 15 May, Aramco posted an 82% year-on-year increase in net income to US\$39.5bn – setting a new quarterly earnings record since its 2019 initial public offering (IPO). Its president and chief executive, Amin H. Nasser, said the company remained steadfast in its commitment to providing energy security and stability for the world.

“We are investing for the long-term, expanding our oil and gas production capacity to meet anticipated demand growth,” he noted.

Its average total hydrocarbon production reached 13mn barrels of oil equivalent per day (boepd) during the first quarter.



# Collaborate Innovate Succeed



Royal Mechanical Group Pty Ltd T/ as Royal Oil and Gas is an Australian company established in 2020. We aspire to meet or exceed the expectations of our internal and external stakeholders through our innovative solutions in the global pipelines and process services market.

**ROYAL**  
**OIL & GAS**



## KEY PRODUCTS AND SERVICES

Pipelines and Process Services

Nitrogen Services

Inline Inspection Service

Pigs, Pig Detection Equipment

Subsea Valves, Receptacles, Hot stabs and bespoke manifolds

Pig Launchers and Receivers

Flow measurement equipment rentals

KEY INTERNATIONAL OEMS  
REPRESENTED BY ROYAL  
EXCLUSIVELY IN AUSTRALIA



### AUSTRALIA

Head Quarters  
+61 (08) 6102 5151

### INDIA

Royal Mechanical India Pvt Ltd  
+91 98 7172 8446

### QATAR

Petromec Trading & Contracting  
+974 7054 2545

### BOLIVIA

Petrosoil Servicios Integrales S.A.  
+591-75372140

[sales@royalmechgroup.com](mailto:sales@royalmechgroup.com)

[www.royalmechgroup.com](http://www.royalmechgroup.com)

[www.linkedin.com/company/royalmechgroup](http://www.linkedin.com/company/royalmechgroup)

## Saudi Arabia leads the way

Indeed, Aramco was able to inject fresh momentum with its Zuluf oilfield expansion contracts during the first quarter – providing a major uplift for contractors in the region.

This entailed multiple contracts, most recently for EPC work to JGC Holdings worth between US\$2bn and US\$2.5bn. JGC has received orders for the construction of the core onshore gas oil separation plant (GOSP) and utility facilities, including water injection.

Aramco is promoting the Zuluf programme to lift more heavy oil as part of overall plans to grow total upstream oil production to 13mn bpd by 2027, up from 12mn bpd.

It follows the award of other major Zuluf contracts earlier in the year to Abu Dhabi's National Petroleum Construction Company (NPCC), McDermott International of the US, and a consortium of L&T and Subsea 7.

There is likely to be more to follow as the Saudi oil giant steps up efforts to increase production capacity, progressing with engineering and construction at Marjan and Berri that will add a combined 550mn bpd of crude oil by 2025.

Last November, it also commenced development of the vast Jafurah unconventional gas field, the kingdom's largest non-associated gas field. Aramco awarded 16 subsurface and EPC contracts worth US\$10bn for the Jafurah gas plant and gas compression facilities, as well as infrastructure and related surface facilities. Capital expenditure on this project alone is expected to tally US\$68bn over the first 10 years of development, with notable recipients including Saipem and Hyundai.

Earlier this year, China's Wison Engineering was also awarded a lump-sum EPC contract by Aramco for a gas processing project at the Shaybah oil field.

“The UAE is likewise seeing strong EPC activity.”

## UAE major project activity

The UAE is likewise seeing strong EPC project activity, as it looks to raise its own oil and gas production capacity. At the start of this year, Wison Engineering also landed an EPC contract to build and install a fine chemical module within the UAE, highlighting a parallel move into more sophisticated niches. The units will be built in China before being transported for installation locally.

Other winners again include NPCC, after ADNOC awarded it a contract worth almost US\$1bn for the strategic long-term development of the Umm Shaif field. The EPC award means NPCC will play a key role in maintaining Umm Shaif's 275,000 bpd



Image Credit : Adobe Stock

**Qatar is another rich source of work for EPC contractors.**

crude oil production capacity and enhancing the field's long-term potential.

Abu Dhabi hopes to lift its oil production capacity to 5mn bpd by 2030, up from 4mn bpd. More work is in the pipeline across the emirates, with other large-scale developments planned.

McDermott was also successful in securing front-end engineering design (FEED) services for the new Fujairah liquefied natural gas (LNG) facility. Located approximately 250 km from Abu Dhabi, the facility will include an LNG plant with a total capacity of 9.6 mn tons per annum (Mtpa) – an EPC award is anticipated next year. McDermott was involved in the initial phases of ADNOC's LNG development back in the late 1980s, having built the storage facilities for both LNG and liquefied petroleum gas (LPG) on an EPC basis on Das Island.

“Our biggest differentiator is our ability to execute this FEED on a fast-track basis incorporating all of the characteristics required to support the award of EPC contracts which are expected in 2023,” said Tareq Kawash, senior vice president, onshore, for McDermott.

## Qatar gas sector momentum

Qatar has been another rich source of work for the world's leading EPC contractors.

McDermott again has won a mega offshore contract from QatarEnergy to deliver engineering, procurement, construction and installation (EPCI) services for the North Field East (NFE) Topsides and NFE Offshore Pipelines and Subsea Cables projects. It also includes an option for the North Field South (NFS) Offshore Topsides – together representing one of the largest single contracts in the company's history. The

project will be managed and engineered out of the McDermott Doha office with significant fabrication taking place at QFAB, the McDermott-Nakilat joint venture fabrication yard in Qatar.

The NFE development will provide feed gas into four new LNG trains currently under construction in the country and, together, with the NFS infrastructure, which will provide feed gas for the future additional LNG trains, will enable an increase in total LNG production in Qatar from 77 million tons per annum (MTPA) to a massive 126 MTPA. It's a huge undertaking.

The scope of the McDermott contract includes the fabrication and installation of eight wellhead topsides (WHT) for NFE and a further five for NFS. The significant subsea portion includes over 500 km of pipelines and, in addition, the installation of over 225 km of 33kV subsea cables and associated works. As well as the QFAB yard, additional fabrication works will be conducted in Indonesia.

QatarEnergy also recently awarded major EPC work to Técnicas Reunidas linked to a number of key growth initiatives. Its role includes expanding the existing liquid product storage and loading facilities required for future additional LNG trains that are planned for the NFS project, as part of an US\$800mn EPC contract.

Separately, Técnicas Reunidas also landed a US\$600mn deal for NFXP Sulphur Project, in a joint venture with Wison Engineering. This entails the construction of new sulphur handling, storage and loading facilities from the expansion of the LNG plant at Ras Laffan Industrial City. The new facility will process an average of 5,000 tons of molten sulphur every day. ■

# TECHNICAL REVIEW

النشرة التقنية - الشرق الأوسط

MIDDLE EAST

[www.technicalreview.me](http://www.technicalreview.me)

## The region's leading trade publication

Now in its 38<sup>th</sup> year of publication, *Technical Review Middle East* has established an enviable reputation for the breadth and depth of its editorial. It is distributed throughout the MENA region, contains an exceptional range of subjects, and is read by senior managers, key buyers and specifiers.

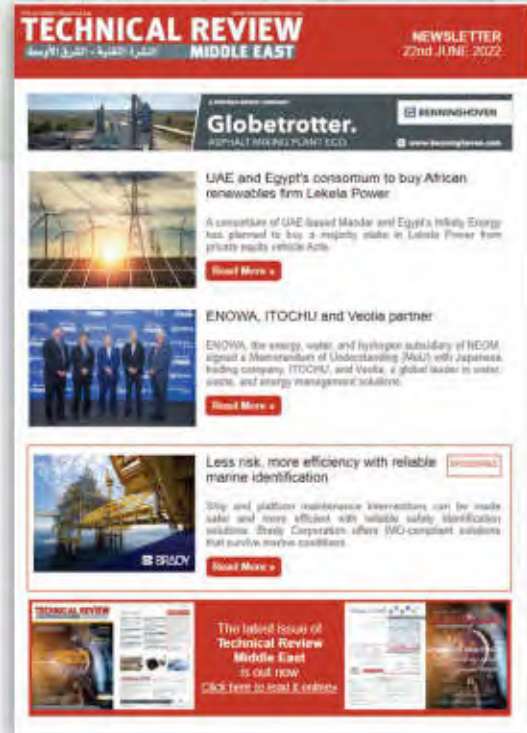

Sign up for the FREE fortnightly e-newsletter on

**[technicalreview.me](http://technicalreview.me)**

**Alain Charles Publishing**  
*Serving the world of business*



MENA Tel: +971 4 448 9260  
 ASIA Tel: +91 98800 75908  
 USA Tel: +1 203 226 2882  
 EUROPE Tel: +44 20 7834 7676

E-mail: [comms@technicalreview.me](mailto:comms@technicalreview.me)  
 Web: [www.alaincharles.com](http://www.alaincharles.com)  
[www.technicalreview.me](http://www.technicalreview.me)

# The evolving nature of oil spill response

Andy Nicholl, principle preparedness & response authority at Oil Spill Response Ltd., discusses considerations responders need to be aware of as new marine fuels are developed.



**T**HE TOPIC OF Low Sulphur Fuel Oil (LSFO) was thrust into the spotlight in July 2020 when the MV Wakashio vessel ran aground in Mauritius. At the time journalists noted that this fuel is relatively new to the market, some referring to it as a ‘Frankenstein fuel’.

Over 30 years ago, only two types of marine fuels were considered to be the main concern: Fuel Oil (FO) and Marine Diesel Oil (MDO).

Since this time, a raft of emission control regulations have been developed and implemented by the Marine Environment Protection Committee of the International Maritime Organization (IMO).

In the period 2007–2012, annual greenhouse gas emissions from shipping amounted to approximately 1,000 Mt of CO<sub>2</sub>, representing around 3% of global man-made emissions (IMO, 2015). Reducing this burden is important in terms of the Paris Agreement commitments, and further regulations are expected in the future to support the ongoing drive to decarbonise shipping.

There are two principal ways in which

operators of ships can comply with the regulations:

- Use of compliant fuel, collectively referred to as Low Sulphur Fuel Oil (LSFO).
- Continuing to use traditional high sulphur fuels, but investing in exhaust gas after-treatment to remove (“scrub”) sulphur from the exhaust gases.

The traditional marine bunker fuel market has consequently been supplemented by a wide range of new, cleaner next-generation fuels, designed to comply with the prescriptive specifications required under the Global Sulphur Cap. Other fuels that have the potential for contributing to this revolution include Liquefied Petroleum Gas (LPG),

methanol, bio-fuels, synthetic methane, hydrogen and ammonia.

But what happens when one of these new fuels is accidentally spilled in the marine environment? Responders, such as Oil Spill Response Limited (OSRL), are familiar with the characteristics of conventional Fuel Oil and Marine Diesel Oil, together with the respective clean-up techniques that can be applied in the event of a spill, but the new generation fuels are potentially very different.

Fundamentally, whenever an unfamiliar oil type is spilt, there are five questions responders need to know:

## 1. Will it flow?

The pour point is the temperature below which the oil ceases to flow. This is determined by the chemistry of the oil including the presence (or absence) of wax and other constituent compounds. Oil spilled into a marine environment quickly assumes the surrounding sea’s ambient temperature, however, if the sea temperature is below the pour point of the oil, the oil will cease flowing and behave as a semi-solid, highly viscous material.

“The new-generation blended low-sulphur fuels have a much broader range of pour points.”

This is typically the case with traditional high-sulphur FO, however, the new-generation blended low-sulphur fuels have a much broader range of pour points, which may well be lower than the ambient sea temperature at the time and place of a spill. In this scenario, the oil will continue to flow and spread easily, with implications for which response techniques are most effective.

## 2. Will it spread?

A spill of MDO has a low viscosity at all ambient temperatures and will spread thinly in all directions over a wide sea area. With the new-gen blended LSFOs, however, there is no set standard for the viscosity at ambient temperatures.

“Without knowing the actual characteristics of the oil that has been spilled, response efforts could be hampered.”

## 3. Can it be dispersed?

Dispersants applied from aircraft, surface vessels or subsea are sometimes used to treat spills of crude oils. Typically, this technique is normally ruled out for spills of Fuel Oil on account of the higher viscosity quickly rendering this technique ineffective. However, the lower viscosity of some blends of LSFO may enable a longer window of opportunity during which dispersant may be effective.

## 4. Can it be picked up?

Heavy viscous oils may have limited spreading characteristics but they are problematic to recover, in part because these semi-solid materials are very difficult to pump. Skimmer manufacturers have developed several innovative methods to overcome this hurdle, but this makes equipment selection critical when building stockpiles for preparedness and at the time of a response.

Furthermore, conventional Fuel Oil (FO) can be very sticky, adhering to any substrate or material that it encounters. These properties again have implications for response that are already well understood by responders. ■

## 5. How can planning for response to a marine fuel spill be improved?

One of the problems responders face is that the physico-chemical parameters that are provided on Safety Data Sheets, and other specifications that accompany marine fuel, typically relate to refinery-based composition or operational combustion characteristics rather than “real-world” fate and behaviour when spilled into a marine environment.

The challenge is not just restricted to new-gen LSFO but applies across all marine fuels including new technologies now being used to power ships such as MSAR, LNG and, of course, traditional High Sulphur Fuel Oil, which is still used widely.

Due to the potentially wide variation in product characteristics, without knowing the actual characteristics of the oil that has been spilled, response efforts could be hampered with potentially detrimental consequences on impacted resources.

However, the response community is adaptable and resourceful in finding solutions to practical issues of combatting spilt oil in ways that are sympathetic to the environment. ■

# EGS



## Euro Gas Systems

Euro Gas Systems is the largest Ariel authorized packager and distributor in Europe, bringing world-class compression to the Middle East, Europe, Asian, African and CIS market at competitive pricing levels.

Our company specializes in designing and manufacturing equipment tailored to client specifications.

EGS's portfolio consists of :

- reciprocating compressor packages
- centrifugal compressors
- screw compressors
- air-cooled heat exchangers
- gas engine driven generators
- service and maintenance





YOUR COMPRESSION SOURCE

www.eurogassystems.com

# Subsea technology solutions for the offshore energy sector

Scott Stephen, regional general manager – Middle East at Ashtead Technology discusses business prospects for the company in the Middle East.



Image Credit: Ashtead Technology

## Can you tell us about your business and how you view the Middle East market?

Established in 1985, Ashtead Technology has grown organically and through strategic acquisitions to become a leading provider of equipment rental solutions, advanced underwater technologies and support services to the global offshore energy sector. Through our three service lines – Survey & Robotics, Mechanical Solutions and Asset Integrity – we support the installation, IMR (inspection, maintenance & repair), and decommissioning of offshore energy infrastructure.

Ashtead Technology has an established presence in the Middle East, and we strengthened our position with the acquisition of Abu Dhabi based TES Survey Equipment Services in 2016. In 2019, we invested in a new facility in Musaffah, Abu Dhabi, to expand our footprint and increase the range of equipment and services offered to customers in the region.

The Middle East survey and robotics rental market is extremely buoyant with access to high-quality, project-ready equipment in high demand. At Ashtead Technology, we boast the largest independent rental fleet in the industry with more than 17,000 assets, and continue to invest to ensure we can offer the broadest and most technologically advanced equipment available to support our customers' projects.

Our mechanical solutions capabilities continue to grow in the region with increased demand for our subsea cutting, dredging and coating removal technology solutions to support various IMR and decommissioning work scopes. We have made some quite substantial investments in developing and mobilising equipment spreads to support customer projects in the region and ensure we have equipment ready to deploy locally, demonstrating our commitment to growth in the Middle East.

## How are you planning to develop your business further in the region?

As well as my appointment this year, we have strengthened our local team, including relocating some of our expertise to support our growth in the region. This enhanced capability is helping us to increase our visibility and use our enhanced knowledge and expertise to solve a wider range of customer challenges.

We are also bringing new technologies to the market in the Middle East, and recently signed a multi-year agreement with Norway-based NORBIT Subsea, to serve as the exclusive reseller for the sale of their multibeam sonar survey systems across the region. These systems are industry-renowned for their exceptional performance, innovation and reliability and are in high demand with our customers.

## How are you supporting the energy transition and sustainability in the offshore sector?

As a market leader in subsea technology rental and solutions, Ashtead Technology's offering sits firmly at the heart of the energy transition, providing critical late life and decommissioning support to the oil and gas industry and supporting the extensive growth in offshore wind globally.

Through continued investment in our equipment rental fleet, advanced technologies and people, we are continually improving the sustainability performance of our business to meet the current and future needs of our customers and help achieve cleaner and sustainable energy production.

The energy transition is rapidly impacting the adoption of remote operations to help reduce carbon footprint, increase operational flexibility and lower HSE risk and costs. Through our remote operations centres in the

UK and Canada, we are seeing significant uptake for our remote inspection services for the integrity management of subsea infrastructure.

Offshore renewable energy has become an important part of our business, now accounting for a significant proportion of our Group revenue. We have a growing track record in the delivery of offshore wind projects utilising our skilled people and their wealth of subsea operations expertise together with our equipment and facilities to deliver best in class, cost-effective offshore wind farm installation and operations solutions.

## How important are innovation and continuous improvement to your business?

As a progressive, technology-driven business innovation is at the heart of what we do and integral to our growth strategy. We are continuing to invest in the latest subsea equipment from leading manufacturers, while also working with industry partners and the supply chain to support the development of new technologies and methodologies, playing our part in the global drive to improve efficiency, reduce cost and safety risk and minimise carbon impact.

Furthermore, we develop our own in-house technology solutions across our three service lines to help meet our customers' operational challenges and ensure we remain at the forefront of what we do.

Our commitment to continuous improvement has allowed us to strengthen our asset integrity service offering through advances in our data management, analysis and reporting capability, whilst our mechanical solutions team has implemented a number of enhancements across our shear cutting, diamond wire cutting and water abrasive cutting solutions portfolio.

**What differentiates Ashtead Technology?**

Ashtead Technology has a 37-year track record and strong international footprint, serving customers from our nine service centres in key offshore energy hubs.

With the largest independent fleet of rental equipment in the industry, we pride ourselves on our responsiveness and the quality of our service offering so customers can rely on us to deliver fast-turnaround technology solutions to meet and exceed their expectations.

Our people are experts in their field and are fundamental to our success. Therefore, mentorship and on-the-job training is a critical part of our business to ensure that essential expertise is nurtured within and passed on to the next generation of talent, enabling them to excel and thrive in a fast-growing environment.

In line with our core values of agility, collaboration and excellence, this commitment to people development and continuous improvement allows us to work together as a global team to achieve more, upholding the highest standards in all we do.

**Looking ahead, what's next for Ashtead Technology in the Middle East?**

The Middle East represents a significant



*Ashtead Technology is a leading provider in the offshore energy sector.*

Image Credit: Adobe Stock

growth opportunity for our business and we are committed to ongoing investment in our facilities, equipment and people to meet the anticipated increase in demand for our specialist technologies and services in the region.

While the global focus on energy transition remains critical and is among the highest policy priorities for the Middle East's oil producers, offshore oil and gas production has increased in recent months, driven by energy security and affordability concerns. For

regions like the Middle East, significant investment is still required to arrest production decline from existing fields and continual IMR of infrastructure is required to maintain and extend the life of producing fields.

Based on the fungibility of Ashtead Technology's equipment and solutions across the offshore wind and oil and gas markets, we are ideally placed to support our customers' evolving subsea technology requirements across both these adjacent markets. ■

**Resoptima**

# Actionable reservoir intelligence

— improved asset performance

Resoptima is revolutionising the way asset teams learn how their reservoirs behave. Our market-leading ensemble-based modelling integrates all subsurface uncertainties to deliver a thorough understanding of the risks and opportunities associated with reservoir management activities. Our clients build compelling business cases for the right projects that will improve recovery factors and optimize the NPV of their assets.

[Resoptima.com/intelligence](https://Resoptima.com/intelligence)

# Optimising flow meter data for better decision making

Dr Yanfeng Liang, mathematician at TÜV SÜD National Engineering Laboratory, describes how flow meter data can be optimised by generalising data-driven models.

EVERY DAY, THE oil and gas industry generates vast amounts of data containing valuable information that could aid businesses in their operational and strategic decision making. In order to unlock and extract the value that lies within that data, advanced modelling techniques such as machine learning models have become increasingly important, where information such as the condition of instruments, fault detection and diagnosis, and future performance forecasting can be obtained.

However, previous studies have shown that the performance of flow meters which belong to the same technology subgroup (e.g., Coriolis, electromagnetic, ultrasonic), can still vary under the same operating conditions due to differing build and manufacturing materials, therefore making it less than straightforward to pinpoint the reasons behind sub-optimal performance. In addition, the performance of flow meters is dependent on operating conditions such as flow profile and pipe configuration.

TÜV SÜD National Engineering Laboratory's data acquisition systems have logged and archived 20 years' worth of data, detailing various flow meters' performance, test facility configuration and operating conditions. The data contains many factors that could influence the performance of flow meters; for example, pipe configuration and the meter size.

To offer insight into the reasons for sub-optimal performance, we conducted experiments on four meters of different sizes within two technology subgroups, where they were deliberately set up differently and exposed to various conditions and disturbances.

Our study revisited the historical data gathered from Meter Category A (Meter A) and Meter Category B (Meter B). Differing sizes were exposed to different setups, where factors such as different pipeline configurations and having disturbance in the system were considered.

Simple plots were initially produced to compare the performance of these meters,



*The oil and gas industry generates vast amounts of data.*

Image Credit : TÜV SÜD National Engineering Laboratory

where only a limited amount of insight was obtained, and it was challenging to interpret the degree of impact of changing operating conditions. Motivated by this, we used various statistical techniques and machine learning models in an attempt to better compare and visualise the performance of the meters under each set up, as well as detecting the presence of a specific faulty condition within the system. These advanced modelling techniques allowed for more comprehensive insights to be extracted from the data and provided a more conclusive representation of the performance of each meter.

It was found that Meter A outperformed Meter B by showing the least degree of drift from the baseline value measured by the percentage error in volume flow. It was also observed that the full-bore Meter A and Meter

B that we studied, had a similar drift pattern when changing from one operating condition to another. The effects of changing pipeline configurations in the system were more predominant in full-bore meters.

The presence of a faulty condition in the system, if undetected, can significantly affect the reliability and the accuracy of outputs from flow meters. Therefore, having the ability to detect a faulty condition ensures that any issues are rectified promptly and minimises the risk of errors propagating and affecting other related measurement outputs. Consequently, we trained and built seven machine learning models under three scenarios, where a mixture of data coming from different meters was used to detect a specific faulty condition within the system, based entirely on the underlying patterns and trends in data.

## Training models

In our previous studies, machine learning models were typically trained and validated using data generated from a single flow meter. Although the models usually performed well with high prediction accuracy, it was challenging to apply the trained models to other meters due to the fact that the models were trained on variables that were unique to a particular flow meter. In other words, the

“ These advanced modelling techniques allowed for more comprehensive insights to be extracted from the data.”



training sample space was restricted. Since, in this case, the meter diagnostic data was not logged during the original experiments, it provided an opportunity to explore the potential of building a more generic model that is trained based on a wider sample space involving data coming from multiple meter types.

Despite having no diagnostic data available, high prediction accuracy (97% to 99%) and high sensitivity rates (0.96 - 1), accompanied by low false positive rates (0 - 0.07), were still obtained, by successfully detecting when a set of data was gathered under normal operating conditions versus the faulty conditions. These research results highlight the potential of making better use of data coming from different meters in order to expand the sample space to allow for a more generalised model to be trained and built, which would be capable of predicting specific operating conditions.

Certain data can be expensive to collect, for example, erosive flow data, but a reliable machine learning model often requires a large volume of sample data in order for it to capture all hidden patterns and correlations in multiple variables. However, it is sometimes not feasible or cost-effective to collect a large



**Dr Yanfeng Liang, mathematician at TÜV SÜD National Engineering Laboratory.**

amount of expensive data for the sole purpose of training a model. As a result, if a model can be trained using a variety of data from different sources, it would maximise the potential value in data as well as make better use of smaller batches of expensive data from different sources. In other words, it would prevent smaller batches of expensive data from being wasted due to their unsuitability in training a

machine learning model as a result of their small sample sizes, if used independently.

It seems that a common requirement from end-users is 'plug and play'. However, this is extremely challenging as models are typically bespoke to specific customer requirements/devices. By having generalisable models, we can offer faster deployment and enable automation by reducing the requirement for fine tuning to specific meter type, manufacturer or model numbers. This will also improve the fault diagnosis process, enable condition-based monitoring and minimise any unexpected downtime. Future research within TÜV SÜD National Engineering Laboratory will continue to explore the potential and capability of generalising data-driven models to be applied in wider applications. ■

*TÜV SÜD National Engineering Laboratory is a world-class provider of technical consultancy, research, testing and programme management services. It is also a global centre of excellence for flow measurement and fluid flow systems and is the UK's National Measurement Institute for Flow Measurement. [www.tuvsud.com/en-gb/nel](http://www.tuvsud.com/en-gb/nel)*

Image Credit: TÜV SÜD National Engineering Laboratory

## Royal Oil and Gas on rapid growth trajectory in the Middle East

ROYAL MECHANICAL GROUP Pty Ltd (Royal Oil and Gas), a young Australian oil and gas services company, is growing rapidly with vertical integration of products from collaboration partners Online Electronics Asia Pacific, FES UK, Flowhire UK and NGPK Inline Inspection Tools.

With offices in Australia, India, Qatar and Bolivia, the company is on a rapid growth profile in the South East Asian and the Middle East markets, focusing on end-to-end solutions for:

- Pipeline pre-commissioning and commissioning services
- Pipeline de-commissioning services
- Design and development of subsea products such as subsea flowback manifolds, flushing and test manifolds, free flooding modules
- Design and development of mechanical structures associated with pipeline and process services
- Umbilical monitoring and testing services
- Flange management and leak testing services
- Nitrogen services

Sales revenue has doubled within the last two trading financial years with 3x earnings growth year on year. Moreover, Royal has invested more than AU\$530,000 in developing a new product segment based out of Australia.

Royal is making a name for its



**Royal Oil and Gas is prospering in the Middle East.**

collaborations, innovations, competitive pricing and fast responsiveness to ease client pain points and gain repeat business.

"We aim to be an Australian oil and gas services company of choice, committed to delivering quality projects in a safe and timely manner," the company says.

Royal has been nominated in the Subsea Energy Australia Awards 2022 for the Subsea

Exporter award, Craig Black Award for Innovation and Technology and Industry Collaboration award.

*To learn more about company prospects, send an email to [info@royalmechgroup.com](mailto:info@royalmechgroup.com). For any enquiries regarding the fleet of equipment and services, do get in touch with [sales@royalmechgroup.com](mailto:sales@royalmechgroup.com).*

Image Credit: Royal Oil and Gas

# Minimising CO<sub>2</sub> emissions – the Blue e+ way

Rittal's unique enclosure cooling technology enables significant energy savings, thereby significantly reducing carbon footprint.

**S**USTAINABILITY IS HIGH on the global agenda, alongside digitalisation. Companies need to find workable solutions to reconcile political and environmental concerns with growing energy needs as well as the economic challenge of rising electricity prices. Customers are increasingly factoring into their purchasing decisions a company's sustainability credentials.

So it's a win-win both for users and for our future. Rittal's new cooling units with their lower cooling outputs of 300, 500, and 1,000 watts – called "Blue e+ S" – add to the Blue e+ family and bring with them additional smart capabilities. Solutions that reduce carbon footprint during production are in high demand.

Blue e+, Rittal's efficient range of enclosure cooling units, was launched in 2015. Since then, the range has continuously been developed, advanced and upgraded. Average energy savings compared with conventional cooling units are in the region of 75%, which translates into a significantly reduced carbon

footprint. What's more, Blue e+ boasts one-of-a-kind technology, extended service life for the installed components thanks to reduced temperature fluctuations, as well as global usability and integration into the IoT. Its revolutionary energy efficiency is achieved due to its ingenious hybrid technology, featuring two parallel cooling circuits that can operate independently or in tandem with each other, depending on the temperature fluctuation. The uniqueness of the Blue e+ technology uses the interactive nature and power of passive and active cooling circuits, which continuously adapt perfectly to the ambient conditions with maximum efficiency.

Blue e+ units are ideal for all industry sectors and environments. A range of efficient solutions exists for every requirement and application:

“It's a win-win both for users and for our future.”



Image Credit: Rittal

Ignatius Emanuel, marketing manager, Rittal Middle East FZE.

- A wide output range covering all cooling requirements from 0.3 – 5.8 kW
- Sheet steel design for all typical industrial sector applications
- Stainless steel and chemical options available for challenging environmental conditions
- Robust outdoor version with anti-vandalism features
- International approvals and multi-voltage capability for worldwide use

“It has always been an honour to be associated with a responsible world leader providing industrial cooling solutions, and especially supporting the initiative of reducing carbon footprint. It is indeed amazing to have such solutions to offer, supporting the industry and environment at large,” said Ignatius Emanuel, marketing manager, Rittal Middle East FZE. ■

Further information can be found at: [www.rittal.com/blue\\_e\\_plus\\_s](http://www.rittal.com/blue_e_plus_s)

Image Credit : Rittal



Blue e+ units are ideal for all industry sectors and environments.

# Positive growth for offshore communications

The offshore oil and gas communications market is expected to increase by US\$1.35bn from 2021 to 2026, at a CAGR of 6.64%, according to Technavio.

ONE OF THE key factors driving growth in the offshore oil and gas communications market is the increasing investment in enhancing network infrastructure.

For decades, the oil and gas industry has relied on its own telecommunications networks, according to the Technavio analysis. In times of crisis, these privately owned and maintained networks are utilised to handle day-to-day operations and coordinate emergency assistance.

Many mission-critical networks nowadays face a two-fold dilemma. First and foremost, there is a need to modernise. Today's demands on infrastructure, such as real-time data, sophisticated control and monitoring closer to the network edge, and high-level security, surpass what narrowband networks can offer. The second point to consider is the need for good communication. Oil and gas field communications necessitate dependable, durable, and high-capacity wireless networks that can operate across broad areas and in harsh environments.

The digitalisation of oilfield communications is another factor supporting the offshore oil and gas communications market growth. The fast acceptance of 4G wireless communication technology and the evolution of 5G standards to accommodate industrial use cases will open up more options for the oil and gas industry to deploy private long-term evolution (LTE) and 5G networks. There is still a lot of uncertainty when it comes to 5G adoption plans in the oil and gas business. However, it is apparent that 5G will become a significant competitive advantage for oil and

“The increasing cybersecurity risks will be a major challenge for the offshore oil and gas communications market during the forecast period.”



Image Credit : Adobe Stock

*Distinct aspects of the oil and gas industry come with different risks and therefore different tactics.*

gas companies in the near future.

Oil exploration and production (E&P) is becoming more efficient and agile, fuelling ambitious digital projects in the E&P sector of the oil value chain. The benefits of 5G would include ultra-reliable low-latency communication (URLLC), massive machine type communication (MMTC), and enhanced Mobile Broadband (eMBB).

## Key offshore oil and gas communications challenge

The increasing cybersecurity risks will be a major challenge for the offshore oil and gas communications market during the forecast period. Because the industry uses connected technology such as the Internet of Things (IoT) and artificial intelligence (AI),

cyber attackers have been targeting crude oil and gas businesses with sophisticated attacks for years.

Distinct aspects of the oil and gas industry come with different risks and therefore different tactics. Development drilling and production have the highest cyber risk profiles among upstream operations, while seismic imaging has a lower risk profile. The increased requirement to digitise, eStore and integrate seismic data into other disciplines could increase a company's risk profile in the future. Apart from its critical infrastructure classification, the upstream industry's sophisticated computation, networking and physical operational procedures scattered throughout the globe make it extremely vulnerable to cyberattacks. ■

# Empowering the connected industrial economy

The importance of contextualised as opposed to raw data, data sharing and empowering the connected worker were among the key themes highlighted at the AVEVA PI World conference held in Amsterdam from 16-19 May.

**A**VEVA, A GLOBAL leader in industrial software, showed how information – contextualised industrial data – is fundamental to sustainable growth across the energy, manufacturing, and infrastructure sectors, while unveiling its product roadmap to industry leaders and partners at the event.

"Information-led innovation provides a proven and responsive pathway to industrial growth at a critical time when the business landscape has been reshaped by turbulence and risk. Industry is facing very complex challenges. Business leaders face increased sustainability compliance requirements, retiring workforces, and the ever-present demand for efficiency, agility and resilience. Raw data in itself is not immediately useful or even understandable, but when you analyse and contextualise it into insightful information, that's when you can help the industrial world to innovate at scale on the road to a net-zero future," said AVEVA CEO Peter Herweck.

"When you talk about all this data, it is key to have the best visualisation available; that means giving the right information at the right time to the right person in the most reasonable way to generate action.

"It's not only about technology, but also about changing business processes, and your facilities and clients' facilities, and helping people to utilise and get the best out of the technology," he added.

Amish Sabharwal, AVEVA executive vice president for Engineering, and Gregg Le Blanc, AVEVA senior vice-president, Information Management, outlined the company's integrated portfolio and elaborated on the product roadmap for 2022 and beyond.

Le Blanc highlighted the importance of data sharing and the connected industrial economy, through "being able to activate, transform that data into information and share it securely with others. Using the data in that way unlocks different capabilities that can drive new insights. Our software can help you



Peter Herweck, CEO AVEVA and Amish Sabharwal, executive VP for engineering, AVEVA.

have a transformational impact on how you use data, turn it into information and get those insights. And you can optimise your entire value chain around that.

“Approximately 68% of currently available enterprise data goes unused because it sits in organisational silos.”

"Approximately 68% of currently available enterprise data goes unused because it sits in organisational silos, yet more data is being created than ever before. AVEVA software enables data to be aggregated, transformed and shared within companies and with external partners, unlocking innovation at scale for all players within a new and connected industrial economy," Le Blanc said. AVEVA Data Hub, a SaaS solution that was launched earlier this year on AVEVA Connect,



Image Credit: AVEVA

the industrial cloud platform, provides data sharing capabilities enabling businesses to unlock operational efficiencies, increase sustainability, and drive digital transformation.

## Embedding sustainability with the digital twin

Sabharwal explained how the digital twin helps embed sustainability across industrial enterprises.

"The digital twin recreates a physical asset in digital form by capturing, organising and contextualising data in a quantifiable form. When these models are used to forecast future scenarios, they can predict potential problems and improve asset reliability, reducing costs and resource use, and minimise carbon emissions. AVEVA's digital twin is uniquely able to capture engineering, operations and maintenance data to provide a holistic, integrated view across multiple use cases," Sabharwal said.

AVEVA recently further strengthened its digital twin software with a host of new features that make visualising asset information with real-time data faster and

easier than ever. With AVEVA Point Cloud Manager and AVEVA Asset Information Management, as well as new 3D wearable scanning and advanced document management, AVEVA customers can now experience a complete digital twin within just 60 days.

“Digital twins have never been more important,” continued Sabharwal. “They will play a central role in uncovering opportunities to unlock ingenuity and achieve the efficiency and sustainability gains needed to enable net-zero carbon emissions. Yet, a digital twin is only as good as the data that composes it.

“With the new integrations and our cloud-native solutions, customers looking to develop and enhance their digital twin can now design, construct and operate sustainable facilities by using data-driven insights to optimise processes and decisions across the value chain.

“The result is a scalable solution that allows companies to leverage existing technology investments and accelerate insight through universal, contextualised access of all engineering, operations and maintenance information in the cloud, using any form of visualisation (3D-models and/or laser scans), and built-in analytics.”

Giving some examples from the energy sector, Sabharwal highlighted a producer of LNG energy carriers which is connecting engineering and operations data to be able to model the behaviour of the asset around the world, while Shell has delivered 30 digital twins with plans to expand that number to 44. “They’re up to 200 use cases on how they can improve reliability, safety and sustainability of their existing assets, around a third of which relate to reducing carbon footprint in their facilities.”

Sabharwal noted, “Aramco has the biggest digital twin offer in the world today. They’ve released 50 RFQs for their engineering companies and suppliers to deliver digital twins across their assets to help them make decisions in their operations.”

More than 1,500 delegates from around the world attended the four-day event in person, while an estimated 1,000 others interacted online. They were given an overview of new developments with industry-leading solutions including AVEVA Connect industrial cloud platform and AVEVA PI System operations information management. Learning labs offered hands-on technical practice in cloud and data environments.

### Customer use cases

Throughout the event, customers and partners from more than 70 companies in 12 industry verticals shared their experience of the data-led digital transformation, and how it is helping them to tackle the complex challenges of the current industrial landscape.

In the energy sector, for example, the USA’s **Dominion Energy** is leveraging data



Image Credit: Adobe Stock

*Digital twins can unlock efficiency and sustainability gains.*

sharing to meet their ESG reporting requirements. By aggregating data from remote wind and other assets, and connecting their PI systems to AVEVA data hub, the company is able to share renewable energy data with their customers, showing them how their energy is being delivered, and demonstrating that the energy produced is

“Aramco has the biggest digital twin offer in the world today.”

from renewable sources.

Jan Broekman, VP global engineering & smart modularization, at engineering company **McDermott**, offered insights into how the company deploys digital tools to facilitate EPC integration from design and fabrication to commissioning, and promote good decision making and collaboration. He shared that the company has launched a digital tool that enables the design and development of facilities to be optimised to reduce GHG emissions, highlighting that sustainability is now a key driver in project design, along with cost and scheduling.

**TotalEnergies** showed how it has put in place a robust data management system and data contextualisation platform allowing data sharing, deployment and maintenance, which has enabled the breaking down of business

silos and the easy integration of new use cases. It has developed an efficient system of energy and emissions monitoring based on the same information, tracking the digital journey of the molecule, and allowing optimisation use cases to be built on top of monitoring use cases.

**Eni** discussed its data democratisation journey enabling digital transformation supporting its upstream operations. It has developed a dynamic digital oilfield platform based on the AVEVA PI system deployed on a giant brown oilfield, using AVEVA software to create a live monitoring tool. This has created a flexible and collaborative environment to engage operators into a continuous and virtuous asset optimisation process, facilitating the shift from data to information, enabling next generation decision making and maximising know-how impact. It has produced major results in terms of emission events and flaring time, unplanned upsets, energy management, energy efficiency and GHG emission reporting.

**Aramco** described how equipment underutilisation has become a challenge in the era of maturing fields. It has utilised AVEVA PI suites in pursuit of equipment reliability, to build an interactive equipment monitoring tool that is more responsive, adaptive and intelligent, allowing real-time performance monitoring and timely alert notifications. Benefits include increased plant availability, reduced equipment repair costs and increased asset health and uptime. The system is being expanded, with more than seven operating departments now using the same tool. ■

# Boosting production while reducing methane emissions

At the Offshore Well Intervention Middle East 2022 conference, Mustafa Adel Amer, senior petroleum production technology engineer and well integrity management at BAPETCO, guided the audience through an expert case study focused on well production and methane abatement.

**A**DEL AMER BEGAN by explaining the latest goals set out to reduce methane emissions whereby, at COP26, more than 100 countries signed the global methane pledge to cut methane emissions by 30% by 2030. Methane emissions are now at the centre of climate discussions and the abatement of them is, and will become, key to the competitiveness of fossil fuels in the future.

The upstream sector, Adel Amer continued, is assumed to contribute around 80% of the methane emissions in the industry,

with the majority of this coming from venting operations. Given the global desire to abate methane emissions, it is therefore of paramount importance for operators to reduce this without affecting production rates.

In pursuit of this, Adel Amer presented a case study from his company which focused on treating liquid loaded gas wells in a method that reduced methane emissions and saved significant money.

Adel Amer said, “Liquid loading in a gas well is the inability of produced gas to produce the entrain liquids from the wellbore.

Over time, gas velocity decreases and liquids in the well will impact the lift performance that reduce or even stop gas production.”

“Over time, gas velocity decreases and liquids in the well will impact the lift performance.”

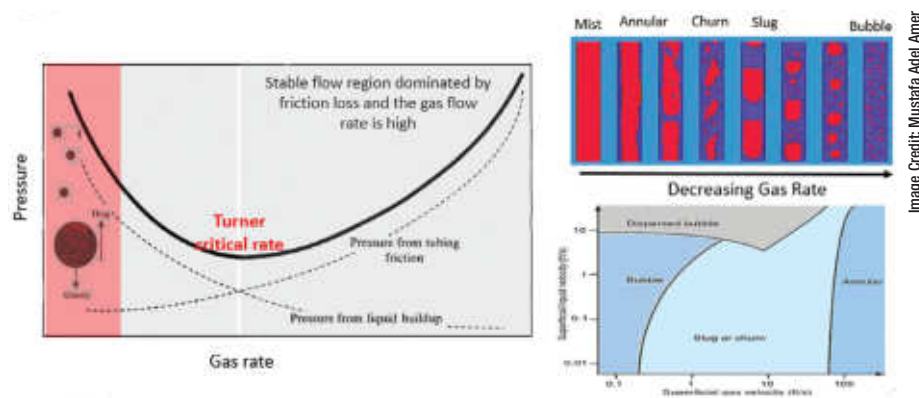

Figure 1: Vertical lift performance curve, liquid loading, and flow regimes.

“Turner discovered the liquid loading could be projected by a droplet model illustrating when droplets move up or down depending on the velocity relative to a critical velocity.”

(See Figure 1).

Adel Amer explained that is common to use VLP to diagnose liquid loading where, in practice, critical velocity is generally defined as the minimum gas velocity in the produced tubing required to produce with low probability of liquid loading risk.

“With the Turner approach, the droplets accumulate in the large ID section but bubble flow takes place at the very low gas flow rate, you need very low gas rate usually at the far left end of the VLP curve. In many cases you

Option	Cost	Well Integrity Compliance	Reservoir Damage	Safety	Environmental Impact
Replace completion	Red	Green	Red	Green	Red
Produce intermittently	Green	Green	Green	Red	Red
Install velocity string by snubbing	Red	Red	Green	Green	Green
Run 2" CT	Green	Red	Green	Red	Green
Run VS without killing and SCSSSV	Green	Green	Green	Green	Green

Image Credit: Mustafa Adel Amer

Figure 2: Assessment of operational options to reduce completion size to end liquid loading in gas wells.

don't see the size of liquid columns that you would expect to balance the drawdown when the well is shut in for cycles."

Mustafa, in his presentation, presented technical analysis showed that wells that operate in their unstable, hydrostatic dominated, part of their VLP suffer from increased liquid holdup along the entire well.

"We therefore need to focus on increasing velocity across the entire well," Adel Amer remarked.

In order to do so, BAPETCO showed a solution performed on an old well located in an onshore gas field with over 10 wells suffering from liquid loading and run under manual unloading cycles. The well chosen was an old one, beyond 17 years of operation, which had a five inch completion. The task was to end the cyclic behaviour of wells to increase production and eliminate methane emissions.

Considering the context of the field and the company in terms of near wellbore damage after well killing and the well integrity manual that mandate having operable sub-surface safety valve in all gas wells, the best solution as Adel Amer said, "was to run a velocity string without killing the well while maintaining the sub-surface safety valve

operable and without reliance on a snubbing unit." (See Figure 2).

They began by conducting surveillance to select the best candidate wells through in-house developed python code that analyses reservoir data, production data, well history, and well integrity history to gain insightful analytics of the well integrity failure history,

“ We now have a new way of dealing with intermittent gas wells.”

potential gain, clearance of the well etc. They then selected candidates and examined the potential in terms of possibility of success and expected gain.

Once done, they went to the PIPESIM (steady-state multiphase flow simulator) to model the surface network and make sure production gains coming from fixing the intermittency of the gas wells would not be constrained by network capacity or connection with other high pressure wells in the network.

The modelling results indicated that

Cost Reduction



Increased Production Performance

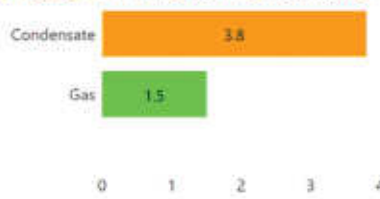

Image Credit: Mustafa Adel Amer

Minimized Environmental Impact

Monthly reduced GHG emissions are equivalent to 4.4 M miles of average passenger vehicle emissions.



Operation Efficiency

Reduced work load on production operations

Well Integrity

Compliance with the Well Integrity Standard

Reservoir

Reservoir killing avoided

Figure 4: Project results.

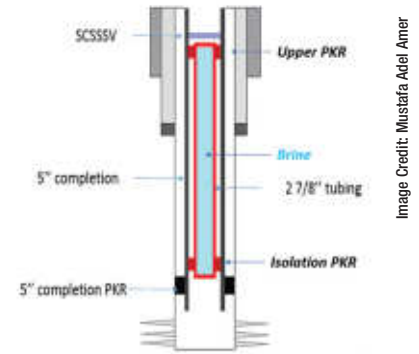

Image Credit: Mustafa Adel Amer

Figure 3: Schematic illustration of the completion after running velocity string.

inserting 2 7/8 inch completions reduced the risk of liquid loading over the completion string and maintained liquid loading velocity ration favourable for stable gas production.

In practice, to run the velocity string without killing the well, without snubbing units and while having operable sub-surface safety valve, the operating included:

- Rigless inspection of the existing five inch completion and settling an isolation packer with surge disk.
- Workover to run the 2 7/8 inch and set an upper packer below the sub-surface safety valve.
- Rigless coiled tubing to unload the brine and break the surge disk. (See Figure 3).

Adel Amer said, "This was completed successfully and the project converted the well from one with a fluctuation intermittent behaviour to a more stable state. The stability of production increased to 2.5MMSCF/D after applying the velocity string, up from a 1.5MMSCF/D the day before the project."

The project helps to achieve various positive results including:

- Cost reduction: the cost of using workover rig to run the 2 7/8 inch tubing inside the existing 5 inch completion was only 10% of a snubbing unit with payback time of 5-6 weeks.
- Increased the gas production rate by 1.5 times and condensate production by 3.8 times.
- The monthly reduced GHG emissions per well is equivalent to 4.4mn miles of passenger vehicle emissions.
- Reduced workload on production operations from elimination of manual unloading.
- Maintained compliance with well integrity standards. (See Figure 4).

Abel Amer concluded, "We now have a new way of dealing with intermittent gas wells which is less expensive, does not kill the reservoir and maintains an operable sub-surface safety valve. Even though liquid loading is a dynamic process, using PIPESIM provided a very useful clue to estimate the liquid loading velocity ratio which was among the main design parameters." ■



The FloFuse technology has demonstrated many benefits in optimising field development.

Image Credit : Adobe Stock

# Ensuring effective flow distribution

Osama Abazeed and Mojtaba Moradi, Tendeka, discuss how a new technology has ensured effective flow distribution and optimised production in a heavy oilfield in Oman.

**D**ISTRIBUTION OF INJECTED fluids is critical for achieving effective oil sweep or chemical treatment. The presence of highly permeable zones or fractures prevents effective fluid distribution, leading to lower recovery factors and premature water breakthrough in production wells.

Tendeka, the global production optimisation specialist, has developed FloFuse, an autonomous rate limiting device to control the flow of injected fluids into high permeability zones. The technology ensures effective flow distribution in fractured or highly heterogeneous reservoirs to prevent excessive water injection into the fractures and thereby enable distributed or matrix injection.

In 2021, a major Middle East operator undertook its first trial of this technology in a new long, horizontal injection well in a heavy oilfield in Oman. This successful application was then extended to other injectors in both water and polymer phases in the field.

## Benefits of autonomously limiting flow

Alternative completion options for conformance control of the water/polymer inject wells in the heavy oil field were considered by the operator before selecting FloFuse. These include:

- Passive inflow control device (ICD)
- Sliding sleeve device (SSD) assembly with ICD
- SSD with control line
- Interval control valve (ICV) with control line.

FloFuse is a biased, open valve which enables water injection at normal

distributed rates but chokes once a trigger rate is exceeded (**Figure 1**). In the choked or fused position, a high flow restriction is applied reducing the injection rate in that zone.

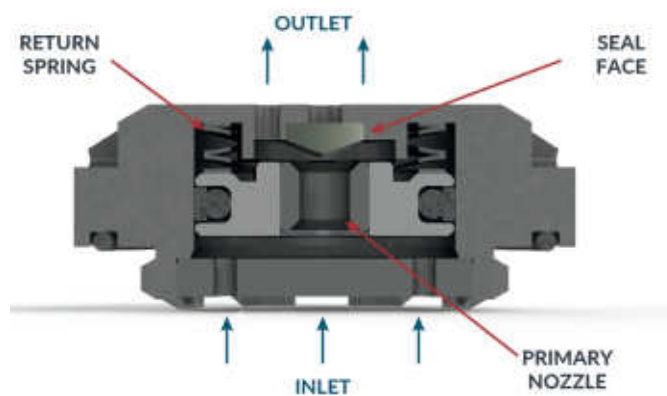

Image Credit: Tendeka

Figure 1: Cross-section of the FloFuse valve.

The normal distributed rates and trigger rate are engineered for optimum performance in each application. The valve remains dynamically reactive and will re-open if distributed flow can be achieved. It is deployed as part of the lower completion or retrofitted into an existing well where the valve is mounted into the basepipe or screen section. The lower completion is segmented into multiple compartments or zones with one or more devices within each zone.

The device is fully reversible and the valve will re-set if the rate becomes sufficiently distributed again. The target normal operating rates and degree of outflow control and trigger rates can be varied by application.

“Distribution of injected fluids is critical for achieving effective oil sweep or chemical treatment.”



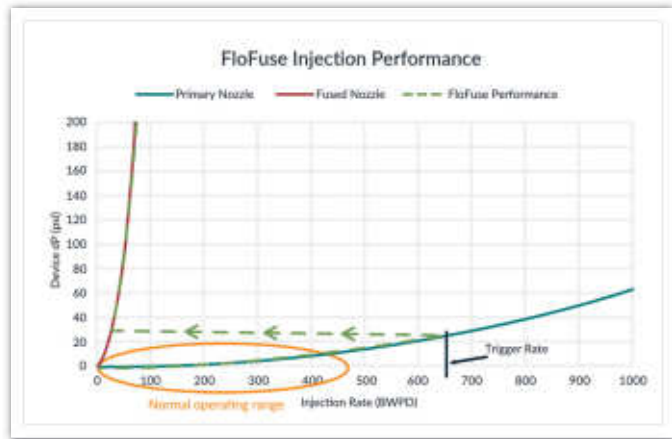

Figure 2: Performance of FloFuse when injecting water.

### Trial process and performance

Under normal operating conditions injection outflow passes through the 'normally operating nozzle' and into the valve housing and through the screen as required. The pressure drop across the completion is defined by the primary nozzle (blue curve) as shown in **Figure 2**. The presence of a fracture or high permeability area in one zone will cause the flow into that zone to increase.

If the trigger flow rate is exceeded, the primary nozzle will switch to secondary and reduce the flow area of the fused nozzle (red curve).

“The technology will be installed in all future polymer injectors in the field.”

This will cause an increased pressure drop across the completion, reducing the flow to that zone. If the permeability is stable, these conditions will persist. However, if diverting flow to other zones causes fracturing or stimulation, further zones may be choked. Once a sufficient number of zones have been fractured or stimulated, conditions for distributed flow are re-established and the FloFuse primary nozzle will re-open.

However, since the well in the trial was planned to be drilled and injected with polymer, further testing was carried out to define the parameters and performance of the valve at various viscosity levels versus water. This was a critical step to acquire the most accurate reservoir model based on the actual type of fluid injected into the reservoir at different stages. This helped decide the size and number of valves to be used in each zone to achieve the required injection window, and importantly, how this completion is expected to operate within this window.

The vendor tested three different sizes of this valve with four different types of injected fluid, water, and then polymer at three

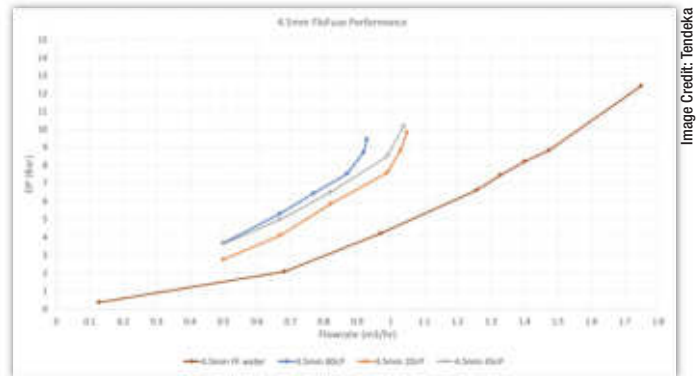

Figure 3: FloFuse performance in different viscosities.

varying viscosities of centipoise (cP): 20cP, 45cP and 80cP. Those values cover the actual type of fluids to be injected in this well (**Figure 3**). The FloFuse valve demonstrated the ability to perform in a mix of different viscosities.

### Well model and completion design

The well had seven zones of completion and only five of them were to be completed. The main objective was to maintain a balanced injection distribution in case of injectivity changes in one or more zones due to initiation of fractures.

While the target injection was set to 350m<sup>3</sup>/day of polymer into the reservoir, the well model covered several scenarios and sensitivity cases of fracture initiation in different zones. A total of 13 FloFuse valves and nine bypass valves were used to complete the five compartments. The bypass valves allow the autonomous device to re-open again after it triggers should the injection rate drops below the tripping rate, and to provide minimum injectivity required in each zone should several valves trip at the same time. The compartments were segmented using swellable packers that were pre-designed with feedthrough capabilities to allow the fibre optic cable to pass through for monitoring purposes.

### Production optimisation

In general, the well is injecting in each zone as per the design with small acceptable deviation, resulting in very good overall injection conformance in the well. This is supported through periodic distributed temperature sensing (DTS) surveillance, where almost 90% conformance has been achieved. With this improved conformance, it is expected to realise good sweep in the reservoir, resulting in improved oil production in the nearby supported producers.

FloFuse technology clearly demonstrates many benefits in optimising field development and as a practice, is a viable option to replicate in similar field environments. It is considered a 'game changer' by the operator to reduce the cost of stimulation and running production logging tools (PLTs). Going forward, the technology will be installed in all future polymer injectors in the field. ■

## Oxford Flow receives award for ES axial flow valve

OXFORD FLOW HAS been awarded the Albert (Al) Woelfel Best Mechanical Engineering Achievement (BMEA) Award by the American Society of Mechanical Engineers (ASME) at OTC (Houston) for its ES axial flow valve. The valve, which has been designed with no mechanical actuator, stem or drive train, is proven to eliminate fugitive emissions, significantly increase reliability and is considerably smaller and lighter than existing valves on the market.

Dr Chris Kennell, technical sales manager at

Oxford Flow, said, "Up until recently, the valve industry has only brought forward iterative engineering design improvements with no major changes to the classic valve blueprint. However, the most common failure points of valves are the stem and actuator mechanical linkage. Without reimagining the design, operators remain trapped in a cycle of spending millions in maintenance to prevent leaks, causing significant safety risks or impacting the environment. The ES valve was designed with

the intention of solving an industry problem, creating something that was not only easy to retrofit into existing systems, but that would provide assurance to operators to know that their operations are now safer and more environmentally sound."

The ES valve is certified to ISO 15848-1 Class A and provides notable assurances of leak elimination in comparison to the standard Class B certification, which is typically seen across the industry.

*Oil industry operators face challenges posed by deposition, emulsion and flow monitoring.*



Image Credit: Adobe Stock

# Addressing industry challenges with tomographic imaging

Leading smart image processing company ROCSOLE is helping companies to reduce OPEX, avoid unplanned shutdowns, monitor product quality and cut carbon emissions with AI and deep learning solutions. Oil Review Middle East spoke to its CEO, Mika Tienhaara.

**O**IL AND GAS companies face new challenges on a daily basis. Whether it is in downstream, upstream or subsea, overcoming these challenges costs time, money and resources. Although production is at an all-time high, multiple factors create a demand for precise process control and quality management. Challenges posed by deposition, emulsion and flow monitoring – including water cut – are not something operators should take lightly.

Globally, more than 60% of operating assets are ageing. This makes operating and production conditions much more severe today. These facilities have, for instance, water breakthrough, meaning a lot of water production compared to the oil production rate. Such facilities also have to deal with sand and solids and all the contaminations carried from production fluids. Around 70% of oilfield production has unconsolidated rocks, which cause sand and solids production. These can cause erosion, corrosion and leakages, making it even more challenging for the facilities to make processing efficient to reach the production quality.

This is where ROCSOLE's See Beyond tomographic imaging system solutions come into play. Its field-proven applications include emulsion, deposition, sand, and flow regime related imaging, and its services are applied on offshore and onshore pipelines, tanks,

and separators, for improved process control and monitoring.

Tienhaara explains that tomography is a way of generating signals in various ways – with X-rays, radioactive, electrical – and processing and interpreting those signals. It has been used widely in the healthcare sector, for example in CT scanning, or with electrical tomography using electrodes on the body to sample if there is water in lungs, for example. "It is a life-saving technology," he says. Finland, home to ROCSOLE, is in fact a pioneer in tomographical technologies in the healthcare sector.

“ In processing industries, the main causes of failure are the level devices and sensors.”

"So, we had the idea of making this robust and reliable technology available for industrial processes, where you have harsh and dirty conditions – very different from the healthcare environment," says Tienhaara.

"In processing industries, the main causes of failure are the level devices and sensors, which can't cope with harsh conditions, dirt, contamination, emulsions, deposits etc, and operators cannot tell what's going on because

you can't see inside steel pipes and steel vessels. Maintenance, for instance, is 75% unplanned due to the fact that operators don't have data and run to failure, and lack good management systems. They need good data and useful insights from these harsh conditions, otherwise they lose uptime and productivity and experience unexpected shutdowns, resulting in higher carbon emissions. For example, flaring systems will burn off more hydrocarbons with unexpected shutdowns.

"So we developed electrical tomographics which can sense any fluid or matter in processes and determine two major values: connectivity and permittivity. That helps whether you are dealing with oil, water or emulsions, and you can also look at the solids build up."

ROCSOLE has received an Offshore Technology Conference (OTC) Spotlight on New Technology award for its Intelligent Level Detection & Data Analytics for Sand Management. In oil and gas facilities, sand production is an unwanted element. Robust and reliable sensors are critical for automated sand management systems to secure the proper functionality and avoid unexpected shutdowns or reduced production rate. ROCSOLE's Separator Profiler physically sees and measures the separator's emulsion layer, improving separation efficiency by optimising residence time and resulting in higher quality output downstream.

“Because we are sampling so frequently with many data points per second, you get real time interpretation of what’s going on, which enables production optimisation,” Tienhaara continues. “The operator can get alerts or alarms, for example, if something needs changing in the chemical treatment programme or the level settings need to be modified, if there are power trips, or the pumps are not working. It results in more efficiency, higher productivity and lower costs.”

### Focus on sustainability

Tienhaara stresses the sustainability aspect of the technology.

“All this together works alongside deep decarbonisation. Everyone needs to look at what they can do in terms of moving to carbon neutrality. We must act now – energy production and manufacturing processes together account for more than 50% of the

anthropogenic GHG emissions. Of course we need a better energy mix, but renewable energy infrastructure takes time to build, and we are not looking at a situation where oil and gas is being shut down tomorrow. We need to make sure that mature production is as good as possible; make it low carbon, avoid and remove operational issues. Being able to detect waste streams, deposits and solids build-up in real-time is providing considerable benefits for our customers to improve their efficiencies and ESG measures.”

Tienhaara sees strong potential in the Middle East, where the company is working with major operators experiencing these issues in terms of emulsions, level measurement and sand management.

“We are working with reliable partners in the GCC countries. UAE, Saudi, Kuwait and Oman have their own specific problems, which go into our black box and we work to



*Mika Tienhaara,  
CEO ROCSOLE.*

Image Credit: ROCSOLE



*ROCSOLE's tomographic solutions can provide accurate emulsion measurement in separators.*

solve them. It's about problem solving and creating value.

“So, that's the journey we're on, and the Middle East is an exciting area because there is a lot of work to do. As with any customer, you have to have patience, especially if you are a start up; you have to prove how the technology works, why it's better, and how it can be integrated into existing systems. You have to have that customer-centric focus.” He adds that the technology is easy to use – “It's plug and play.”

“With technology, it should always be that it solves a problem and creates value. It's about collaboration and creating win-win situations,” Tienhaara concludes. ■

## LYTT launches new data visualisation dashboard

LYTT, A PROVIDER of sensor-enabled analytics solutions, has delivered an upgraded iteration of its data visualisation dashboard, spotLYTT version 2. The tool provides oil and gas operators with an enhanced user experience and unlocks powerful multi-channel analyses to run multiple projects simultaneously. The next-generation user interface also allows for the visualisation of sensor fusion insights – using multiple types of sensor data from different sources at once to provide a more complete operational view.

Before the launch of spotLYTT v1 last year, the oil and gas sector had few interactive data analytics visualisation solutions available. Since then, spotLYTT has been widely deployed alongside LYTT's app suite, and has generated additional value for projects worldwide. As energy operators increasingly deal with complex wells and integrated global portfolios, LYTT has worked to build out its scalable and cost-effective solutions to address these evolving challenges.

spotLYTT v2 includes user-specific dashboard customisation and an enhanced user experience, streamlining workflows to help customers rapidly understand their asset data and isolate the root causes of operational challenges. spotLYTT v2 uses upgraded, cloud-based architecture to maintain performance for a larger global user base.

Through the spotLYTT user interface, LYTT delivers actionable insights derived from its suite of applications addressing flow, solids, integrity, and

seismic challenges for energy operators. LYTT's flow applications in particular have gained significant traction within the sector over the last year, as they enable customers to increase operational efficiency and reservoir recovery by solving complex multi-phase flow monitoring challenges in tubulars and subsurface production systems. Crucially, insights are offered continuously and in real-time via spotLYTT, offering increased visibility into well performance.

Çağrı Cerrahoğlu, product manager – Analytics, LYTT, explained, “Oil and gas operators are keen to invest in scalable technologies that help them monitor the performance of their assets. By using connected insights enabled through spotLYTT v2, our flow applications allow operators to dynamically monitor production and injection while building an understanding of the relationship between these variables and their operating conditions, empowering operators to optimise their assets.”

Pedro Vale, chief technology officer, LYTT, concluded, “Understanding our customers' technical needs as part of our product evolution is a key value driver for LYTT. We work closely with our customers to accelerate their digital trajectories and empower them with real-time visibility to make smarter decisions, faster. We look forward to continuing to evolve LYTT's analytics platform and app suites, and, via spotLYTT, helping customers in oil and gas, water and CCS intuitively tackle key operational challenges using sensor fusion.”

Image Credit: Adobe Stock

# Enhancing production efficiency with the digital twin

Vijay Jaswal, CTO – Middle East and Turkey for Software AG discusses how the digital twin can help companies achieve their production and sustainability objectives.

## How can digital twins help to optimise field development and project delivery, and boost production?

A digital twin is basically a digital representation of reality. Digital twins create a virtual model of production assets, with advanced systems that can constantly be updated in real time. The model equips oil and gas operators with tools to upgrade planning and operational standards, provide unprecedented insights and enable predictive analysis through the use of big and real time data to deliver new oilfield insights for action accordingly, thereby increasing efficiencies across oilfields. Digital twins are rapidly becoming a standard for every new and a growing number of existing facilities. In the future, the industry will exist in both the physical and virtual worlds, with a strong interconnected ecosystem for improved production, asset life, efficiency and safety.

In the case of production, through the use of sensors, the production digital twin provides insights into operations which can save time for field workers. Field workers are then able to remotely receive alerts to schedule and address irregular conditions at earlier stages. This is one scenario of how increased efficiency through a digital twin can enable companies to optimise project delivery and boost production.

In fact, Industry 4.0 and the Internet of Things (IoT) have recognised the concept and metaphor of an “IoT digital twin” for some time (attributed to Michael Grieves in 2002). In industry, this is used to plan, test and optimise systems, but also to train employees in their use. In production, a digital twin can also be linked to real-time information for a



Image Credit : Adobe Stock

holistic view of the system. Typical applications include asset monitoring, predictive maintenance and virtual simulations to optimise system performance by changing parameters (such as temperatures, pressure or energy consumption).

A digital twin and metaverse are known to be closely linked – both would require a virtual representation of the oil and gas and allow users to play with the various parameters to boost production and gain the optimum amount of end product out of the refinery. In fact, IoT digital twins will also be seen in the metaverse.

## How can digital twins help companies achieve their sustainability and emissions reduction objectives?

Sustainability in the upstream sector is becoming more important by the year, and the Middle East is making great strides towards lowering its carbon footprint. As the physical and digital worlds converge, digital

twins play a significant role in helping the world overcome sustainability goals and challenges, resulting in operational excellence and supply chain optimisation and planning. Through real time data-rich environment, the digital twin with other integrated technologies can be used as a predictive guide to the future for smarter and informed decisions. The upstream sector in the Middle East is a prime user of digital twins to reduce costs, resources and carbon footprint. IoT digital twins are also expected to pop up in real-life situations from asset management to helping control climate change.

## How can digital twins help to promote collaboration and data-sharing?

An enterprise management system (EMS) is often used synonymously. Within the trend map, the DTO / EMS concept is important for strategic transformations, business model innovation, and operational optimisation (business process excellence).

“The production digital twin provides insights into operations which can save time for field workers.”

The digital twin has emerged as a promising tool in using real-time data visualisation through real-time collaboration to help decision-making processes across all levels of the supply chain. It connects different types of data and systems to create a single view that can be accessed throughout the complete project life cycle. By enhancing data capture, integration and improved real-time visualisation, the digital twin provides advanced maintenance analysis and automation of process workflows for actionable information sharing and collaboration. Digital twins help simulate the environment, perform checks, predict failure possibilities, plan logistics, check progress and more.

**How do you view the adoption of digital twin and other digital technologies in the Middle East upstream sector, and what factors are driving adoption? Are there any examples you would highlight?**

The Middle East is making rapid progress in the adoption of cutting-edge digital technologies in the upstream sector. Digital



Image Credit : Software AG

**Vijay Jaswal, CTO – Middle East and Turkey for Software AG.**

twins are clearly the future technology expected to transform the region. Given their ability to increase time and cost efficiencies and elevate performance levels across the board in the industry, digital twins are gaining widespread acceptance.

Key areas that are driving this adoption are:

1. By replicating the physical environment of real-world processes in a virtual environment via digital twins, companies can drive faster and more effective decisions. With use cases across a digital twin growing, organisations become much more impactful.
2. In the case of the oil and gas sector, market uncertainty is irreducible, and the outlook evolves based on present events, such as the volatility in the oil price. In such scenarios, countries all over the world are exploring non-oil revenues. A digital twin is extremely important in cases such as these where it enables plants and manufacturers to increase efficiencies and boost production to manage volatile environments more efficiently and drive growth, safety and sustainability. ■

## Aramco and Cognite launch joint venture to accelerate digitalisation

ARAMCO AND COGNITE, a global leader in industrial software, have launched CNTXT, a joint venture based in the Kingdom of Saudi Arabia. Headquartered in Riyadh, CNTXT will support industrial digitalisation in the Kingdom and the wider MENA region.

CNTXT will provide digital transformation services enabled by advanced cloud solutions and leading industrial software. These solutions and services will help companies in the public and private sectors future-proof their data infrastructure, increase revenue, cut costs and reduce risks, while enhancing operational sustainability and security. CNTXT is Google Cloud's reseller for cloud solutions in the Kingdom and the exclusive reseller of Cognite Data Fusion in the MENA region. Additionally, Google Cloud is expected to launch a "Center of Excellence" later this year to provide training to developers and business leaders on how to use cloud technologies.

Led by Abdullah Jarwan, appointed CEO of CNTXT, and a management team of local and international talent, CNTXT plans to significantly grow the team this year in the hope of becoming the top tech employer in the Kingdom.

The launch of CNTXT is a major milestone in the collaboration between Aramco and Aker ASA, the majority owner of Cognite. The partnership began in 2019 with the signing of a Memorandum of Understanding (MoU) to develop synergies



Image Credit: AdobeStock

*The joint venture will support digitalisation in Saudi Arabia and the wider region.*

and share knowledge on industrial digitalisation and sustainability initiatives.

Ahmad A. Al-Sa'adi, senior vice president of Technical Services at Aramco, said, "CNTXT brings together industrial legacy, unmatched technology, and a truly talented team that will aid in the digitalisation of the public and private sectors in the Kingdom. CNTXT will be an important catalyst of digitalisation of the Kingdom."

Øyvind Eriksen, president of Aker ASA and chair of the Cognite Board of Directors, said, "CNTXT will be an important vehicle for

driving profitability and sustainability of the Kingdom's industries through innovative use of technology. I look forward to seeing the company accelerate the digital transformation of the most important sectors in the region."

Abdullah Jarwan, CEO of CNTXT, said, "The untapped potential in the digital transformation of the Kingdom of Saudi Arabia and the greater Middle East is enormous. With Google Cloud and Cognite offerings in our portfolio, we can help the public and private sectors innovate faster, scale AI-driven solutions, and turn data into value."

# Three trends shaping the energy transformation

Adnan Merhaba, partner, Energy & Utilities Practice lead, Arthur D. Little Middle East and Carlo Stella, partner, Energy & Utilities Practice, Arthur D. Little Middle East discuss how decarbonisation, decentralisation and digitisation are transforming the energy sector.

**A** GAINST A GLOBAL backdrop of environmental crisis and armed conflict, there is a growing need for meaningful change in the energy sector. While CO<sub>2</sub> emissions continue to exacerbate the climate emergency, the ongoing war in Ukraine is serving up a reminder of the fragility of energy supply in times of unrest. With energy and ecosystems facing a future of uncertainty, the call to action is clear: the sector and its partners must pull together to transform the way they work.

Fortunately, change has already begun. As Arthur D. Little unearthed in its recent report, *Disruption Is Now*, three trends are shaping transformation efforts across the energy spectrum: decarbonisation, decentralisation, and digitalisation. Each trend presents its own raft of challenges, but those challenges are met in equal measure by opportunities, ready for the taking.

## Decarbonisation

From soaring temperatures to changing landscapes, the climate emergency is unfolding before our eyes, and at COP26 commitment was secured to halt – possibly even reverse – the damage. Putting pen to paper at the 2021 conference, many of the world's biggest economies pledged to achieve net zero emissions by 2050 and double their efforts to curb the global temperature increase to 1.5°C.

It is not just a governmental affair; there is private sector resolve to support nations on their respective 'road to zero' journeys. In fact, during COP26, the Global Financial Alliance for Net Zero announced that its participants had committed US\$130 trillion of private capital to effect meaningful change.

“The significance of decarbonisation cannot be overstated.”



Image Credit: Arthur D. Little

Adnan Merhaba, partner, Energy & Utilities Practice lead, Arthur D. Little Middle East (left) and Carlo Stella, partner, Energy & Utilities Practice, Arthur D. Little Middle East.

The significance of decarbonisation cannot be overstated. It will be nothing short of the most important overarching trend shaping the strategic thinking and investment decisions of companies – not just in the energy ecosystem, but in sectors across the board.

## Decentralisation

The impact of the Ukraine conflict on global energy supply is indicative of a broader problem that has long been brewing. In a world of uncertainty, there is a pressing need for a more localised solution where service delivery is concerned, rather than a reliance on a much wider national or regional infrastructure.

The mission for energy stakeholders is to create future-proof infrastructures that can accommodate technologies such as intermittent and decentralised generation. Towards that goal, tried and tested solutions include siting wind farms close to urban areas

or using micro-generation such as photovoltaic (PV) rooftop panels on new housing developments and encouraging energy users to take greater responsibility for how they consume it. All these elements are feeding into new business models that are focused on much greater sustainability – a thread that runs increasingly through every component of society.

## Digitisation

As the Industrial Revolution 4.0 continues apace, organisations across sectors and industries are increasingly turning to digital transformation in order to compete and survive, and energy is no exception. In fact, the digitalisation and automation of processes and practices in the energy sphere will be critical to the success of efforts to transform the sector. By digitising operations, energy players can reduce costs, increase revenue streams, and deliver superior service to

customers. Importantly, digital solutions also enable companies to minimise waste and maximise operational efficiency, with clear sustainability gains and benefits for the environment.

Attesting to the importance of digitisation to the emerging energy paradigm, ADL's report reveals that, besides massive investments in the energy grid itself, the increasing digitisation of operations and flexibility dominate investments.

### The power of hydrogen

Another area attracting both investment and global attention is hydrogen (H<sub>2</sub>) – so much so, the global H<sub>2</sub> economy is expected to be worth US\$700bn by 2050. Green hydrogen in particular has been identified as a key technology to meet decarbonisation ambitions and support the transition toward a greener future in hard-to-decarbonise sectors.

Worldwide, collaborative R&D efforts are

underway to maximise the potential of hydrogen within the global energy matrix. Recently, the UAE and the Netherlands joined forces to boost their H<sub>2</sub> efforts and advance the formulation of projects and initiatives to support the Paris Agreement on climate change. While Abu Dhabi National Oil Company (ADNOC), bp and Masdar have strengthened their strategic partnership to progress the development of clean hydrogen and technology hubs, driving energy innovation for both the UAE and the UK. Germany and Saudi Arabia have also announced a strategic alliance on green hydrogen development that will see the two nations collaborate on the generation, processing, use and transportation of clean hydrogen.

### The path ahead

In context of climate crisis and supply uncertainty, the need for energy transformation is resoundingly clear, and the

“The core business will remain a “cash generator” for the next few decades.”

way in which industry players position themselves today could determine the success or failure of global efforts, as well as their own competitive advantage, for decades to come. From hydrogen to digitisation, the insights revealed in Arthur D. Little's report provide a toolkit to help the sector's decisionmakers to start moving towards their vision of a decarbonised future. ■

To view the report, go to <https://www.adlittle.com/en/insights/report/disruption-now>

## Upstream oil & gas: finding a way to net zero

AS MORE AND more countries set net-zero targets, the upstream oil and gas sector will be increasingly impacted by the accelerating pace of the energy transition, according to Arthur D. Little's *Disruption is Now* report.

The report examines strategies oil and gas companies are adopting in the drive to net-zero. Many companies are shifting their investment to a more focused gas play and venturing into renewable energy generation, hydrogen, and other alternative energy, as well as EVs.

Some oil and gas companies are moving much more aggressively away from hydrocarbons and divesting from countries, regions and portfolio plays to fund their transition into cleaner and greener energy. BP, for example, is moving out of Oman and Algeria; Exxon Mobil plans to exit Malaysia, Europe and Equatorial Guinea; while Shell is leaving Mexico, Malaysia and Egypt.

Others are taking a more gradual approach, maintaining their core production but refocusing on a combination of gas play and carbon capture, use, and storage (CCUS) technologies. Those who have not yet pursued this route are sure to come under increasing pressure to decarbonise from shareholders, the report says.

The oil and gas service sector is quickly adapting to sectoral shifts, with players pushing the competitive boundaries in technologies, processes, and know-how. But to be successful in the energy transformation, service companies, along with the oil and gas companies, will need to work more closely than before, leveraging new partnerships and business models to ensure their survival.

Given that they are still the major energy source used globally and are relatively cheap, oil and gas will remain important in the short to medium term as a means to generate cash to fund decarbonisation initiatives and provide stability, the report says. So, while oil and gas companies will increase investment in decarbonisation, oil and gas exploration and production will continue for the next decade. Oil and gas companies will implement innovative and digital decarbonisation techniques while simultaneously moving their core business forward at a slower pace. But the core business will remain a “cash generator” for the next few decades, especially if they can introduce new operational efficiencies.

### Recommendations

The report makes the following recommendations for upstream oil and gas:



Oil and gas companies are venturing into areas such as hydrogen.

- Harvest existing portfolios with stronger focus on extracting value from existing assets while reducing exposure to frontier exploration or long lead developments
- Shift emphasis from liquids to natural gas
- Improve sustainability of existing operations: energy efficiency actions, renewable sources for internal consumption, reduction of methane leaks, etc.
- Digitalise key processes to reduce operating costs and improve resilience to oil price volatility
- Invest in CCUS and other carbon neutralisation solutions as an option to decarbonise or offset carbon emissions from operations
- Invest in low-cost E&P assets with near-term upside potential and modular flexibility (eg. some low-cost shale operations)
- Make selective acquisitions of E&P independents in financial distress, particularly when operating synergies can be easily captured
- Exit high stranded risk assets such as tar sands or extra-heavy oil fields, and remote assets in sensitive environments with limited infrastructure
- Limit investment in complex/high cost EOR projects in mature assets
- Reduce exposure to frontier exploration blocks or some long-term developments with questionable economics (eg. some deepwater discoveries).

<https://www.adlittle.com/en/insights/report/disruption-now>

# Seeing strong growth potential in the Middle East

Rouzbeh Fazlinejad, managing director and head of oil and gas for the Middle East and Africa at leading global investment bank Houlihan Lokey, discusses the expansion of the bank's oil and gas team in the Middle East.

## What was the rationale behind establishing the oil and gas team in the Middle East?

Oil and gas is a global industry and we want to offer clients a full suite of advisory services across the entire energy value chain, in all major oil and gas hubs and jurisdictions around the world. We currently have more than 80 oil and gas investment bankers based in Houston, Dallas, New York, London, and Hong Kong, and with the potential for further growth in the Middle East, we now have a dedicated team based in Dubai servicing the region.

## How important is the Middle East region in terms of your global business?

Oil and gas are a strong focus for the bank. I joined the team earlier this year to lead the firm's first industry group in the region.

Since opening an office in Dubai in 2017, our team has advised on some of the largest and most complex transactions in the Middle East, covering corporate finance and financial restructuring. We are investing in growing our physical presence in the region because we see the growth potential for our investment banking services. The region is an important financial centre, and as it matures further there is greater need for specialisation.

Globally, Houlihan Lokey is the number 1 investment bank for M&A transactions, having closed over 550 deals in 2021. We are also the number 1 global M&A fairness opinion advisor and have the largest financial restructuring group among investment banks. In the USA, we are the leading investment bank for all energy and power transactions and combined with our international market knowledge and strong local network, we are looking to firmly establish ourselves in the Middle East.

“ We are investing in growing our physical presence in the region because we see the growth potential for our investment banking services.”

## How are you hoping to expand your client offering in the region, and what do you see as promising areas for development?

Houlihan Lokey is the only investment bank in the region with a dedicated team of oil and gas specialists based here. Our team in Dubai has decades of experience across corporate finance, M&A, capital markets, and financial restructuring and can advise clients in the Middle East throughout the entirety of the energy value chain.

## How do you view the M&A market currently?

In the current climate we are seeing large and small companies, both



Image Credit: Houlihan Lokey

*Rouzbeh Fazlinejad, managing director and head of oil and gas for the Middle East and Africa, Houlihan Lokey.*

private and government-controlled, consider strategic alternatives. Typically, we have seen these include strategic acquisitions or divestiture of their assets or portfolio in the traditional hydrocarbon space, or net additions to pursue energy transition, whether through expansion of downstream/petrochemicals or the acquisition of renewable assets.

Traditionally, M&A does not like volatility and the commodity markets of the past few months have seen substantial movements in the price of oil and gas. In the current environment, we are seeing many companies generating strong cash flow, making a strategic divestiture difficult. In addition, buyers are less willing to underwrite projections based on current prices. We are observing a 'keep vs. sell' dilemma in some of our current mandates. We are, however, seeing deal flow pick up and are encouraged by our pipeline of potential transactions in the region. For those owners who choose to keep rather than sell, we are seeing an increase in capital markets activity, as availability for recapitalisations (including for dividends) has been reinvesting in the industry. ■



# Prospects for the shipping market

At the Global Executive Petroleum & Energy Conference (GEPEC), organised by S&P Global Commodity Insights, a panel moderated by Peter Norfolk, editorial director, Global Shipping & Freight, S&P Global Commodity Insights, examined the state of play for shipping.

**B**EGINNING THE DISCUSSION, Jake Seed, research analyst at Galbraiths, remarked that it has been a volatile few years for the freight market, which “fell off a cliff” with the onset of the pandemic in early 2020. For the past two years throughout the pandemic, freight has been at very low levels, translating in many cases into earnings for shipowners at or below operating expenditure and even dipping down, certainly in the case of VLCCs, into negative earnings.

The Russian invasion has had a “big impact” on tanker markets, Galbraith commented.

“On the crude side, the days following the invasion saw a big increase in freight, particularly Suezmaxes and Aframaxes, the two sectors disproportionately affected by the invasion, with shipowners pulling back from lifting cargos from Baltics and Black Sea. That resulted in big increases in rates in those sectors. On the crude side we have seen freight tail off again in the last weeks, largely caused by the fact that VLCCs are still seeing low levels of freight and earnings, and they are cannibalising trade that traditionally would have been lifted on Suezmaxes and Aframaxes.

“On clean, it is a different story; following the Russian invasion, we have seen freight surge, staying at high levels over the last few weeks, largely down to the dislocation in products, with a big increase in ton miles of diesel coming into western markets on LR2s and LR1s, the larger products tankers, as well as MRs seeing increased trade, for example out of North America, with more volumes going down to Latin America as well as heading transatlantic into Europe. This has sustained high rates on the clean side.

“Looking forward over the next few months and into 2023, the big story is the EU sanctions in terms of the embargo on Russian oil imports and insurance ban. This is going to create substantial dislocation in products, particularly now in crude as well; we’re expecting a big surge in ton miles going

*The Russian invasion of Ukraine has had a big impact on shipping markets.*



Image Credit : Adobe Stock

forward as crude into Europe dries up, and Russian crude finds a home elsewhere, east of Suez and increasingly into India as well as more volumes into China. At the same time, Europe is losing Russian barrels, so we are going to have to see replacement volumes from other regions.

“So we will see an increase in freight in the dirty segment, as well as this continued surge in clean.”

## The future bunker fuel market

The panel also examined prospects for the bunker fuel market, and the growth of alternative fuels in the quest for net-zero. Andrew Scorer, freight analytics lead at S&P Global Commodity Insights shared the company’s forecasts for overall bunker demand, highlighting the current heavy reliance on fossil fuels which currently account for 98% of the mix, including 2% LNG, with only around 0.2% accounted for by alternative fuels. By 2030 the share of LNG is projected to grow to around 6%, but 92% is still accounted for by residual fuel.

“By 2050, there will be a massive change, but hydrocarbons will still be there, with LNG a big part of it,” Scorer said. S&P Global Commodity Insights forecasts that of alternative fuels, ammonia and methanol will then hold large market shares of 41% and 32% respectively, with 8% accounted for by

hydrogen and 16% by biofuels. ESG concerns, increasing regulation and ambitious IMO emissions reduction targets will play a role in this shift. While the company forecasts a big increase in trade by 2050, with the main demand coming from dry bulk and containers, efficiencies, design and engine changes, slow steaming as well as changes in behaviour (such as a move to ‘just in case’ from ‘just in time’) will impact the bunker fuel market.

The panel highlighted the role of efficiency improvement technologies as well as future fuels, noting that solutions and technologies such as rotor sails, air lubrication systems and improved weather routing, can all help to reach 2030 targets, improve economies in terms of fuel consumption and reduce costs, particularly in the high bunker fuel cost environment, thus helping to improve ship owners’ bottom lines as well.

It was suggested that while technology is advancing rapidly, the future fuel and freight scenario could become much more complex, with questions remaining over fuel availability; multiple fuels, rather than just one, could be available depending on routes, there could be differing forms of propulsion within the same vessel class and differing bunker costs. This could cause uncertainty for ship owners and charterers, although it could also result in opportunities for niche players on the bunker side. ■

## Ikon Science introduces Data Explorer application

IKON SCIENCE, A leader in geoprediction and open subsurface knowledge management software and services, has announced the launch of the latest version of Curate, a cloud-native subsurface knowledge management service, including the new Data Explorer application.

With data-driven workflows continuing to drive innovation across the oil and gas sector, the efficient search, appraisal and utilisation of information within contained data platforms has grown in importance. Curate allows operators to leverage and contextualise existing data, regardless of the data source, and can help drive faster and more accurate decision-making. This, naturally, aids accelerated exploration, minimising portfolio risk and optimising production.

Data Explorer, the new application included in the latest version of Curate, provides deep searching capabilities and customisable visualisations for even easier access to data.

“We are excited to introduce our Data Explorer application to enable energy companies to gain a more intimate understanding of their data and its quality to leverage specific measurements that can reveal deeper subsurface detail,” said Dr. Denis Saussus, CEO of Ikon Science.

“Our commitment to continuous improvement ensures our Curate portfolio helps energy companies unlock greater opportunities and efficiencies for a better bottom line.”



Image Credit: Ikon Science

*Data Explorer automatically provides customisable visualisations of data.*

## eDrilling introduces wellGuide

WELLGUIDE, A REAL-TIME drilling parameter software to optimise tripping speed, flow, ROP and RPM within well safeguards, is the latest solution from eDrilling, the supplier of AI, machine learning and predictive analysis solutions.

wellGuide is a software solution for rigs where automated drilling upgrades require heavy and costly investment, or rigs that require a drilling advisory system to optimise operation.

During operation, wellGuide utilises optimal parameters, which are calculated in real-time within the limitations of its respective well. All operational statuses are detected and displayed by the software, to find which parameters can be optimised.

Additionally, auto-configuration and auto-calibration metrics are key elements to deploying the software without the need for backend support. Any personnel involved, from drill operators to contractors and service providers, will be able to quickly give the necessary operational input while the software is automatically calibrating its input.

wellGuide is eDrilling's response to an industry moving towards automation, optimised performance and avoidance of non-productive time.

## KROHNE Group refreshes wet gas system: safety first

LEADING MANUFACTURER OF process information, measurement solutions and services, KROHNE Group, has unveiled a refresh to its Venturi-based wet gas system for enhanced well optimisation.

The Venturi-based systems, WGS 1000/2000/3000, are designed to measure unprocessed gas flow directly from the well to a degree of accuracy between 1% and 3%.

Along with its impressive accuracy, the system is also flexible and economical; it can be implemented much quicker than competing systems and is space-saving. To enhance the on-site safety of implementing and using the wet gas systems, KROHNE has reduced overall operating expenditure by delivering the upgraded model, which requires less space and is lighter.

“KROHNE is always looking to enhance customer experience through well-designed innovative solutions. We have been able to deliver on two key areas with this recent WGS upgrade, improving personnel safety and reducing overall operating expenditure. A win-win for our valued partners and customers that we hope they can leverage in upcoming well projects. Watch this space for continued R&D-driven portfolio revolutions,” said Frank Janssens, VP, KROHNE Middle East and Africa.



Image Credit: KROHNE Group

*The unit delivers improved personnel safety and reduces overall expenditure.*

## Genesis multi-phase detector

MAGNETROL-AMETEK HAS ANNOUNCED the launch of Genesis Multiphase Detector, a patented solution for multiphase detection, measurement and control.

Multiphase level measurements exist across multiple industries, but hold a pivotal role in the oil and gas and petrochemical industries due to the value derived from the effective separation of water and hydrocarbons.

The new Genesis Multiphase Detector marks a number of notable engineering accomplishments in the sector of multiphase level management, providing profiler performance at a competitive cost without the regulatory burdens and health, safety and environment concerns of other instruments on the market.



Image Credit: Magnetrol-AMETEK

*The unit operates from a single opening in a vessel.*

The Genesis unit from Magnetrol is designed to measure multiple phases in applications across thick and dynamic emulsion layers: vapour phase; total level (e.g hydrocarbon liquid); top of emulsion layer; bottom of emulsion layer (e.g. water level); and sediment.

The system operates from a 24V DC input with four 4-20mA outputs (including HART) which enables the convenient control of total level, top of emulsion, water level, and sediment measuring.

Concurrent top-down and bottom-up signal generation contributes to the system's accurate results.

Proprietary and innovative software algorithms are deployed to interpret the incoming signals and deliver them to operators.

All these components are delivered from a single opening in the vessel, making the unit one of the most efficient on the market, and combine to supply a superior degree of accuracy.

Magnetrol-AMETEK has been a pioneer in the level instrumentation market since 1932, with the Genesis Detector marking the next step in its evolution.

## HMD Kontro announces sealless pump range addition

JOINING THE FLEET of more than 100,000 pumps operational in the field is HMD Kontro's latest range, comprising 13 Frame 1 and 16 Frame 2 sizes to meet the needs of a wider range of chemical pump applications.

Certified as meeting the ISO dimensional and construction standards 2858 and 15783, the expansion to the CSI line is purposefully designed to focus on additional hydraulics and a feature set to include greater variation in the inlet and outlet sizes. The 29 new models allow for a wider range of flow rates up to 120 cu m/h and heads up to 62m to optimise performance.

The CSI range, and the wider selection of HMD Kontro sealless pumps, are designed to deliver pivotal operational benefits for chemical processing, with operational safety to protect people and environments from aggressive, corrosive and acidic liquids at the forefront of each model.



Image Credit: HMD Kontro

The new unit joins the CSI range.

"The expansion of the CSI range ensures that we can continue to offer a world-class chemical pumping solution for the ISO markets, with not only the highest levels of robustness in the field but with an enhanced customer driven feature set.

"We can also maintain maximum pump configurability with rapid availability, regardless of the specification needed," explained Hannah Verrall, product line manager at HMD Kontro.

The CSI range's modular design allows for maximum part interchangeability, and assists in rationalising the number of pumps required when upgrading existing installations.

Extra features in the range include the ZeroLoss containment shell, which improves hydraulic efficiency by up to 25%, delivered by reduced induction losses.

## SWiG releases underwater communications standard

SWiG HAS UNVEILED a new industry standard for underwater wireless acoustic communication. SwiGacoustic is meeting the demand as the focus on inspection, maintenance and repair of autonomous underwater vehicles (AUVs) grows.

To address the problem of streamlining diverse systems to equip platforms to cover various communications tasks, SWiG JIP (Subsea Wireless Industry Group) was established to focus on defining standards that facilitate interoperability between users of different subsea wireless technologies (radio, acoustic, inductive power and data, free space optics, and hybrid solutions).

Its latest development, SWiGacoustic, targets the provision of a simple acoustic protocol to satisfy the needs of interoperability and interchangeability for acoustic data communication devices. The standard is derived from NATO ANEP-87 Edition A Version.

The standard, which is available to SWiG members via its website, operates within a range where available bandwidth is still appropriate to be of interest for application, a single frequency band to allow for maximum interoperability, and a small enough transducer size that is small enough to be installed in smaller vehicles where size and weight may be limited.



Image Credit: Sagentia Innovation

The solution meets the growing demand for inspecting, maintaining and repairing AUVs.

## MacDermid expands line with Oceanic EL 08

MACDERMID OFFSHORE SOLUTIONS, leader in high-performance and environmentally-friendly products for the offshore oil and gas industry, has expanded its range of products with the new Oceanic EL 08, a biodegradable lubricant.

Oceanic EL 08 serves as a safe and efficient alternative to flammable or hazardous solvents and corrosion inhibitors that are currently used in umbilicals.

Due to its low viscosity and minimal hazards, Oceanic EL 08 can be pumped into long umbilicals both on land and offshore, and can be used to fill, test and store them. The new solution is a minimal-effort lubricant and saves the expense of flushing or displacing aqueous alternatives that are currently the industry standard.

Environmental concerns and costs, as well as the staff requirement for current intensive solutions, can be avoided with Oceanic EL 08.

Eric Handley, vice president of technology, said, "Looking forward, MacDermid will continue creating sustainable, environmental lubricants and fluids needed for energy transition to subsea electrification and carbon capture projects."

## Halliburton partners with Aker BP for next-gen field planning

HALLIBURTON HAS ANNOUNCED that it and Aker BP, a Norwegian oil and gas exploration and production company, will co-develop next generation field development planning software through a new cloud application – Field Development Planning (FDP) – from Halliburton.

It also expands the scope of the current Digital Well Program, a DecisionSpace 365 cloud application, built on an open architecture to provide integrated well planning and design to increase collaboration and connectivity across drilling activities.

Built on the OSDU Data Platform, FDP converts the manual process of collating field development data to make the decision gate process more efficient and auditable and provides a common audit trail across the subsurface community. FDP helps organisations better understand uncertainty and risks associated with field development concepts.

"We are excited to extend our close collaboration with Aker BP and develop a cutting-edge intelligent system to evolve field development from the manual FDP process that exists in most enterprises," said Halliburton chairman, president and CEO Jeff Miller.

"FDP creates a holistic view of field development and well construction, which will allow Aker BP to make more informed and expedited subsurface and reservoir/production decisions to optimise its investment and maximise the return on its assets."



Image Credit: BusinessWire

The partnership will co-develop next-gen field development planning software.

# Project Databank

Compiled by Data Media Systems

## OIL, GAS & PETROCHEMICALS PROJECTS - OMAN

Project Name	City	Facility	Budget (US\$)	Status
ARA Petroleum - Qarat Al Milih Production Station	Al Wusta	Development Drilling & Production	200,000,000	EPC ITB
Canada Business Holdings - Low Sulphur Fuel Oil Refinery	Duqm	Refining	1,500,000,000	FEED
ENI - Block 47 Onshore Exploration and Production	Northern Oman	Development Drilling & Production	300,000,000	Engineering & Procurement
Hydrocarbon Finder - Block 7 Onshore Exploration and Production	Al Wusta	Development Drilling & Production	160,000,000	Construction
Marsa LNG - Sohar LNG Bunkering Terminal (SLNGB)	Sohar	Liquefied Natural Gas (LNG)	250,000,000	EPC ITB
MOL - Block 50 (Masirah Bay Offshore)	Masirah Basin	Exploration	250,000,000	Construction
Oman Lasso Exploration and Production Karwan - Block 54	Al Wusta	Onshore Exploration & Production	50,000,000	Engineering & Procurement
Oman LNG - LNG Plant Upgrade	Qalhat	Liquefied Natural Gas (LNG)	100,000,000	Construction
Oman Wanfang - Crude Oil Refinery	Duqm	Refinery	5,000,000,000	Project Announced
OQ - Block 60 Concession - Bisat Oilfield Development -	Central Oman	Development Drilling & Production	400,000,000	Construction
OQ - Block 60 Concession Development - Overview	Central Oman	Oil Field, Gas Field	1,100,000,000	Construction
OQ - Marubeni Corporation - Salalah2	Salalah Free Zone (SFZ)	Hydrogen	1,000,000,000	Feasibility Study
OQ - Oil Storage and Terminal	Duqm	Offsite & Storage Tanks	200,000,000	EPC ITB
OQ Exploration & Production - Block 60 Concession - Bisat Oilfield Development - Full Field Development	Central Oman	Development Drilling & Production	150,000,000	Construction
OQ Gas Networks - Al-Kamil [ BVS 9] to Sur GSS Gas Pipeline	Sur	Gas Pipeline	300,000,000	Engineering & Procurement
OQ Gas Networks - Fahud to Sohar Second Loop Line	Sohar	Gas Pipeline		EPC ITB
OQ Gas Networks - South Grid Debottlenecking - Phase 2	Various	Gas Pipeline	150,000,000	Construction
OQ Methanol - Salalah Ammonia Plant (Luban)	Salalah	Ammonia	750,000,000	Commissioning
OQ8 - Duqm Refinery - Main Process Units	Duqm	Refining	2,780,000,000	Construction
OQ8 - Duqm Refinery - Offsite Facilities	Ras Markaz	Refining	900,000,000	Construction
OQ8 - - Duqm Refinery - Offsites and Utilities	Duqm	Refining	2,080,000,000	Construction
OQ8 - - Duqm Refinery - Overview	Duqm	Refining	6,000,000,000	Construction
OTTCO - Main Line Oil - Ras Markaz Crude Oil Terminal Pipeline	Ras Markaz	Oil Pipeline	300,000,000	Pre-FEED
OTTCO - Ras Markaz Crude Oil Park - Overview	Ras Markaz	Offsite & Storage Tanks	400,000,000	Construction
OTTCO - Ras Markaz Crude Oil Park - Tanks, Marine, and Infrastructure	Ras Markaz	Offsite & Storage Tanks	400,000,000	Commissioning
OTTCO - Ras Markaz Crude Oil Park - Crude Oil Tanks and Infrastructure	Ras Markaz	Offsite & Storage Tanks	925,000,000	Project Announced
PDO - Mabrouk North East Deep Gas Field Development	Saih Rawl	Gas Field	5,000,000,000	Engineering & Procurement
PDO - Marmul Main Production Station (MMPS)	Marmul	Gas Compression	150,000,000	Engineering & Procurement
PDO - Marmul Main Production Station (MMPS)	Marmul	Offsite & Storage Tanks	70,000,000	Engineering & Procurement
PDO - Marmul Polymer Phase 3 (MPP3) - Production Facilities	Marmul	Development Drilling & Production	270,000,000	Commissioning
PDO - Mazoon Petrogas - Lekhwair Small Fields (LSF) Development	Lekhwair	Development Drilling & Production	100,000,000	Project Announced
PDO - Yibal Rejuvenation	Yibal	Development Drilling & Production	500,000,000	Commissioning
Ras Madrasah Petroleum Industry Company - Genoil Duqm Refinery	Duqm	Refinery	2,400,000,000	FEED
SABIC - OQ - Duqm Petrochemical Plant	Duqm	Steam Cracker		Project Announced
Salalah Petroleum Company - Petrochemical Factory	Salalah Free Zone	Petrochemical Plant	88,000,000	Project Announced
Salalah Refinery (SFZ) - Salalah Refinery Project	Salalah Free Zone (SFZ)	Refinery	2,500,000,000	FEED
Shell Integrated Gas Oman - OQ - Marsa LNG - Block 10	Northern Oman	Gas Field Dev't & Production	2,000,000,000	Project Announced
Shumookh Investment & Services - Sur Refinery & Petrochems	Sur	Refinery	10,000,000,000	Pre-FEED
TotalEnergy - PTTEP - Block 12 Onshore	Central Oman	Gas Field E&P	100,000,000	Feasibility Study



# Stay one step ahead of your competitors

with the DMS Projects Matrix

A critical and essential **business intelligence** tool, updated daily to ensure you are constantly at the top of your **commercial strategies**, allowing you to **maximise your returns** in today's ever **growing global market**.



## REGIONS COVERED

- Asia Pacific
- Middle East
- Latin America
- North America
- Central America
- Russia & CIS
- East Africa
- North Africa
- West Africa
- India
- China
- Europe

## SECTORS COVERED



**SUBSCRIBE TODAY**

or contact us for further information

- [www.dmsprojects.net](http://www.dmsprojects.net)
- [info@dmsglobal.net](mailto:info@dmsglobal.net)
- +971 249 161 71 (UAE Headquarters)
- +973 1740 5590 (Bahrain Office)



# Project Databank

Compiled by Data Media Systems

## Project Focus

Compiled by Data Media Systems

### OQ - Block 60 Concession - Bisat Oilfield Development - Early Production Facility - Station C

<b>Name of Client</b>	OQ
<b>Estimated Budget (US\$)</b>	400,000,000
<b>Award Date</b>	2021-Q1
<b>Main Contractor</b>	Exterran Holdings
<b>Facility Type</b>	Development Drilling & Production
<b>Status</b>	Construction
<b>Location</b>	Central Oman
<b>Project Start</b>	2020-Q1
<b>End Date</b>	2023-Q4

### Background

The project calls for the development of Bisat oilfield located at Block 60. The Bisat was appraised by drilling two horizontal wells revealing oil rates in excess of 1,000 bpd of light oil. Bisat is located 35 km north of the production facilities. The project aims to process and treat a minimum of 330,000 bpd of gross reservoir fluids. This will be made up of 300,000 bpd of produced water treatment capacity and 30,000 bpd of crude oil processing capacity.

### Project Status

Date	Status
Jun 2022	The construction and installation works are progressing as per plan. All the major equipment orders have been placed and almost all the parts are on site ready for installation. The trial production is still expected to begin in late 2023.
May 2022	Arabian Industries has supplied air-cooled heat exchangers for the project through its Arabian Industries Air Cooling Exchange (ACHE) subsidiary.
May 2022	Arabian Industries has announced that the last major piece of equipment, the production separator, has been dispatched to the project's site as part of an order for six large process equipment that has been awarded to the company by Exterran.
Apr 2022	The construction work is ongoing with an anticipated commissioning date of July 2023. Gulf Petrochemical Services & Trading (GPS) is Exterran's civil sub-contractor.
Mar 2022	The construction of the storage tanks is currently underway by Majees Technical Services.

### Project Scope

The project includes:

- 30,000 bpd of crude oil processing capacity
- 300,000 bpd of produced water treatment capacity
- Treatment of produced water to required disposal specifications
- Pumping of produced water to designated disposal water wells at the required injection pressure after treatment.

## Middle East & North Africa

The Baker Hughes Rig Count tracks industry-wide rigs engaged in drilling and related operations, which include drilling, logging, cementing, coring, well testing, waiting on weather, running casing and blowout preventer (BOP) testing.

Country	MAY 2022			VARIANCE		APRIL 2022		
	Land	Offshore	Total	From May 2021	From April 2022	Land	Offshore	Total
<b>Middle East</b>								
ABU DHABI	37	12	47	+4	+1	33	13	46
DUBAI	0	1	1	=1	0	0	1	1
IRAQ	48	0	48	+13	+2	46	0	46
JORDAN	0	0	0	0	0	0	0	0
KUWAIT	28	0	28	+5	+1	27	0	27
OMAN	47	0	47	+4	+1	46	0	46
PAKISTAN	16	0	16	+2	0	16	0	16
QATAR	4	8	12	+1	+1	2	9	11
SAUDI ARABIA	64	14	78	+12	+8	60	10	70
YEMEN	1	0	1	-1	0	1	0	1
<b>TOTAL</b>	<b>243</b>	<b>35</b>	<b>278</b>	<b>+41</b>	<b>+14</b>	<b>231</b>	<b>33</b>	<b>264</b>

### North Africa

ALGERIA	34	0	34	+6	0	28	0	28
EGYPT	26	6	32	-3	0	23	9	32
LIBYA	2	0	2	-10	-5	7	0	7
TUNISIA	2	0	2	+2	0	2	0	2
<b>TOTAL</b>	<b>64</b>	<b>6</b>	<b>70</b>	<b>-5</b>	<b>-1</b>	<b>60</b>	<b>9</b>	<b>69</b>

Source: Baker Hughes

شركات «باسف» و«شبروين ويليامز» و«ثري إم» و«بي بي جي إندستريز» و«أكزو نوبل» - على توسيع دائرة وجودها من خلال تقديم منتجات جديدة. وفي ظل حرص الحكومات، في شتى بقاع العالم، على تنفيذ لوائح موضوعة للحد من الانبعاثات، تستثمر الشركات المصنعة لطلاءات خطوط الأنابيب في مجال البحث والتطوير لإنتاج طلاءات مستدامة من شأنها تقليل الانبعاثات الكربونية، في حين تستثمر قطاعات المستخدمين في طلاءات خطوط الأنابيب المستدامة التي لا تؤذي البيئة والإنسان. ومن أمثلة التطورات الأخيرة:

- في فبراير/شباط 2022، استحوذت شركة «بي بي جي إندستريز» على أعمال تصنيع مساحيق الطلاء الخاصة بشركة «أرسونسي» وسوف يمكنها هذا الاستحواذ من توفير منتجاتها في منطقة الشرق الأوسط وإفريقيا. كما تركز الشركة على جني نسبة 40 في المائة من مبيعاتها من المنتجات المميزة المستدامة.
- في مايو/أيار 2021، تعاونت شركة «باسف» مع شركاء القطاع لاستكشاف حلول مستدامة لطلاءات الإصلاح لتحقيق هدف المركبات العضوية المتطايرة الجديد.
- في أكتوبر/تشرين الأول 2020، وسعت شركة «شبروين ويليامز» خطها الصناعي المتميز من خلال إدخال مادة اليورثان المائي، فمادة الطلاء هذه اختيار مثالي لخزانات البتروكيماويات والطلاء العام، كما أنها تلغي الحاجة إلى قياس وخلط المواد في موقع العمل.

يشجع استخدام الفحص البصري بمعرق مساحين أكفاء للتحقق من جودة خطوط الأنابيب، وهذا يزيد من الخطر على حياة الإنسان، ويمكن ألا يلاحظ أحد بعض الأنابيب المتآكلة في بعض الحالات. ولذا تبادر قطاعات النفط والغاز إلى استخدام الذكاء الاصطناعي والتعلم الآلي لدراسة سلامة خطوط الأنابيب وإصلاح المناطق المعرضة للتآكل. ويستطيع قطاع النفط والغاز، من خلال الاستعانة بهذه الأنظمة، تحليل خطوط الأنابيب وصيانتها من خلال متابعة حالتها بعد طلائها.

شركة «فيوتشر ماركت إنسايتس» متخصصة في أبحاث السوق والاستشارات ومعتمدة من منظمة «إيزومار»، وتخدم عملاءها في أكثر من 150 دولة، ويقع مقرها الرئيسي في دبي، ولها مكاتب في الولايات المتحدة الأمريكية والمملكة المتحدة والهند. وتمتلك منصة «ماركت نغيج» المخصصة لأبحاث السوق، وهي منصة قائمة على الاشتراك وغايتها مساعدة الأطراف المعنية في الحصول على بحث متعمق لمختلف الصناعات والأسواق والقطاعات المتخصصة. يمكنكم الاشتراك في نسخة تجريبية مجانية لمدة سبعة أيام على <https://www.marketngage.com/signup>. ويمكنكم التواصل مع نيكيل على «لينكد إن».

للعوامل الجوية القاسية دوراً جوهرياً في زيادة الطلب على الحفاظ على سلامة خطوط الأنابيب.

وفي ظل وجود بعض خطوط الأنابيب تحت الماء والأرض، تزداد فرص تسرب المياه والأوساخ إليها، ومن الممكن أن يتسبب ذلك في تدهور جودة النفط والغاز. ويتكبد المؤرد والمستخدم خسائر اقتصادية فادحة جراء التسربات وانسداد خطوط الأنابيب، كما يزداد الخطر على حياة الإنسان والبيئة بسبب سوء نقل النفط والغاز. وحرصاً على تجنب ذلك، وضعت الهيئات الحكومية في مختلف البلدان لوائح صارمة، وهكذا تصاعد الطلب على تغطية خطوط الأنابيب بالطلاء.

وقد كشف تقرير لـ «فيوتشر ماركت إنسايتس» بعنوان «سوق طلاءات أنابيب النفط والغاز» (<https://www.futuremarketinsights.com/reports/oil-and-gas-pipeline-coatings-market>) أن مبيعات طلاءات خطوط الأنابيب من المتوقع أن تسجل معدل نمو سنوي مركب إيجابي بنسبة 5,5 في المائة، فتتراكم قيمتها السوقية بمبلغ 6,958 ملايين دولار بنهاية عام 2029.

## قطاع النفط والغاز يفضل طلاء

### الإيبوكسي المرتبط بالانصهار

يشجع استخدام خمسة أنواع مختلفة من طلاءات خطوط الأنابيب لتغطية أنابيب النفط والغاز، وهي طلاء الإيبوكسي المرتبط بالانصهار، وطلاء البولي يوريثين، وطلاء مينا قطران الفحم، والطلاء الخرساني، وطلاء البولي أوليفين. ولكن يشجع استخدام الطلاءات الإيبوكسية المرتبطة بالانصهار لخطوط الأنابيب الفولاذية لأنها مصنوعة من مواد متصلة بالحرارة وتحمي من تآكل خطوط الأنابيب. ويتوقع تقرير «فيوتشر ماركت إنسايتس»، عن سوق طلاءات أنابيب النفط والغاز، أن تسجل طلاءات الإيبوكسي المرتبطة بالانصهار معدل نمو سنوي مركب يبلغ 6,1 في المائة، وصولاً إلى عام 2029. كما يشجع استخدام طلاء البولي يوريثين في قطاع النفط والغاز، إذ يساعد على حماية خطوط الأنابيب من العوامل الجوية والصدأ والتآكل بفضل قدرته على التحمل، كما يمكن التحكم فيه من حيث درجة الشفافية أو اللمعان، ولذا من المتوقع أن يرتفع الطلب على استخدامه سريعاً.

## آخر الابتكارات والتطورات في تكنولوجيا

### طلاءات خطوط الأنابيب

تركز الشركات المتميزة في مجال طلاءات خطوط أنابيب النفط والغاز - أمثال

## ← مفكرة الفعاليات 2022

### سبتمبر/أيلول

www.gastechevent.com	ميلان	معرض غازتيك	8 - 5
www.sogat.org	أبوظبي	معرض التكنولوجيا المتقدمة للنفط الحامض والغاز - SOGAT	8 - 5
www.hse-forum.com	دبي	منتدى الشرق الأوسط وشمال أفريقيا للصحة والسلامة والبيئة	7 - 6

### أكتوبر/تشرين الأول

www.adipec.com	أبوظبي	معرض أدبيك	11/3 - 30
----------------	--------	------------	-----------





الطلاء يزيد من عمر خطوط الأنابيب ويساعد على تقليل انبعاث الكربون

## مستقبل طلاءات خطوط أنابيب النفط والغاز

في هذا المقال، يناقش المهندس نيكيل كيثويد، نائب الرئيس المساعد لأبحاث السوق بشركة «قيوتشر ماركت إنسايتس»، سوق طلاءات خطوط الأنابيب وتزايد الطلب على الحلول المستدامة. وهو يقول إن التعرض للعوامل الجوية القاسية يتسبب في تآكل معدن خطوط الأنابيب، مما يتسبب في تسرب الغاز والنفط ويشكل تهديداً لحياة العمال.

التآكل بدوره سلامة الأنابيب ويخلق فرصة لتسرب الغاز والنفط والتدهور الكيميائي. ومن أمثلة ذلك أن ثلاثة عمال لقوا مصرعهم على إثر حدوث تسرب في أحد خطوط أنابيب الغاز في إيران في يوليو/تموز 2021، وانفجر خط أنابيب في حادث آخر جنوبي إيران في نوفمبر/تشرين الثاني 2021. وقد كان تقادم البنية التحتية للأنابيب السبب الرئيسي لهذا الحادث، ولم يتسبب انفجار خط الأنابيب في سقوط قتلى أو جرحى لكنه تسبب في خسائر فادحة للقطاعات.

وقد تفاقمت مشكلات الصدأ والتآكل بسبب إغلاق أنشطة إنتاج النفط والغاز وقطاعات المستخدمين بسبب القيود المفروضة على الحركة في ظل جائحة فيروس كورونا (كوفيد-19). ويتصدر واقع النفط والغاز المشهد بسبب الطلاء غير المناسب وغياب الرقابة على خطوط الأنابيب في مواقع جغرافية شتى. كما يلعب التعرض

تعدد العوامل التي تعزز سوق طلاءات خطوط الأنابيب، إذ يدفع التعرض للعوامل الجوية القاسية والخسائر الاقتصادية الناجمة عن التسربات والانفجارات قطاع النفط والغاز إلى الاستثمار في صيانة الأنابيب لفترات أطول. كما أن لزيادة الإنتاج وأنشطة الاستكشاف البحرية تأثيراً إيجابياً على الطلب على طلاءات خطوط أنابيب النفط والغاز. وأيضاً للوائح الحكومية المعنية بالحد من الانبعاثات الكربونية دوراً بارزاً في تحفيز عملية إنتاج طلاءات مستدامة لخطوط الأنابيب.

### العوامل الجوية والخسائر الاقتصادية تزيد

#### الطلب على طلاءات خطوط الأنابيب

يتسبب التعرض للعوامل الجوية القاسية في تآكل معدن خطوط الأنابيب، ويهدد

المحررة: لويز ووترز

فريق التحرير والتصميم:

برانشات إيه بي، ميريام بروتوكوفا، راؤول بوتيفيدو، يرافين سبي بي، روبرت دانيلا، ماثيو هايفو، فينا اثنوا، تولانا نايك، الأمير كاريابا، شيفالبي دروف.

### الناشر: نك فوردهام

مدير مبيعات: برينشارد روزيلر

مدير مبيعات المحلة: تانمي ميشرا

هاتف: +918-2678443 - بريد إلكتروني: tanmay.mishra@alaincharles.com

Country	Representative	Telephone	Fax	Email
India	Tanmay Mishra	(91) 8065684483	(91) 8040600791	tanmay.mishra@alaincharles.com
Nigeria	Bola Olowo	(234) 8034349299	-	bola.olowo@alaincharles.com
South Africa	Sally Young	+27101924 906 961	-	sally.young@alaincharles.com
UK	Richard Rozelaar	(44) 2078347676	(44)2079730076	richard.rozeelar@alaincharles.com
USA	Michael Tomaszewsky	(1) 2032262882	(1) 2032267447	michael.tomaszewsky@alaincharles.com

المكتب الرئيسي:  
Alain Charles Publishing Ltd  
University House, 11-13 Lower  
Grosvenor Place  
London SW1W 0EX UK  
هاتف: +44 (0) 7436 7171  
فاكس: +44 (0) 7437 0076

مكتب الشرق الأوسط الإقليمي:  
Alain Charles Middle East FZ-LLC  
Office 112, Loft 2B  
صندوق بريد: 7-22-5  
مدينة دبي للإعلام  
دبي - الإمارات العربية المتحدة  
هاتف: +971 4 448 9310  
فاكس: +971 4 448 9311

الإنتاج: نيلبي هينديز

بريد إلكتروني: production@alaincharles.com

الإشتراكات: بريد إلكتروني: circulation@alaincharles.com

رئيس مجلس الإدارة: دريسك فوردهام

المترجم: عز الدين م. علي - ezzeddinmali@gmail.com  
التصميم والإخراج الفني: محمد هشام النجار - mohammed.hisham.najjar@gmail.com  
الطباعة: مطبعة الإمارات - دبي



Serving the world of business  
Oil Review Middle East ISSN: 1464 9314

## ← محتويات القسم العربي



### تحليلات

4 مستقبل طلاءات خطوط أنابيب النفط والغاز

### ملخص محتويات القسم الإنجليزي:

تقارير خاصة: شركة تطوير نفط عمان.

استطلاعات: إدارة تسرب النفط، الاستخراج المعزز للنفط.

تقنيات: التحكم في التدفق، حقول النفط الرقمية، التقليل من الانبعاثات.

## ADVERTISERS INDEX

Company.....	Page
DMG World Media (Abu Dhabi) Ltd.....	11
DMS Global WLL.....	45
Euro Gas Systems S.R.L.....	21
MABI AG.....	13
Oman Cement Company.....	2
Resoptima.....	23
Royal Oil and Gas.....	17
Spanchem Technologies.....	5



MENA  
**HEALTH, SAFETY &  
ENVIRONMENT**  
FORUM 2022

6 - 7 SEPTEMBER  
Grosvenor House, Dubai, UAE



**EXCLUSIVE  
MEETING POINT**

for end users from the oil, gas & energy sector and HSE solution providers to come together and define their HSE strategy for a sustainable future

**SPEAKERS INCLUDE**

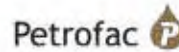

**SPONSORS**



**ASSOCIATION PARTNER**



**CONTACT US FOR SPEAKER AND SPONSORSHIP OPPORTUNITIES**

VINAY NAIR | Head of Business Development | Alain Charles Events  
t: +9714 448 9260 | e: vinay.nair@alaincharles.com  
[www.hse-forum.com](http://www.hse-forum.com)

**OFFICIAL PARTNER**

**Health, Safety &  
Security Review**  
Middle East  
[www.hssreview.me](http://www.hssreview.me)

تُعنى بالنفط والغاز والبتروكيماويات

# النشرة النفطية

المجلد 25 العدد الرابع 2022

الشرق الأوسط

## مستقبل طلاءات خطوط أنابيب النفط والغاز

سوق طلاءات خطوط الأنابيب وزيادة الطلب على الحلول المستدامة